

EVERFLEX®

ISO 9001 CERTIFIED

CATALOG NO. EF3339-6
Dated August 1998

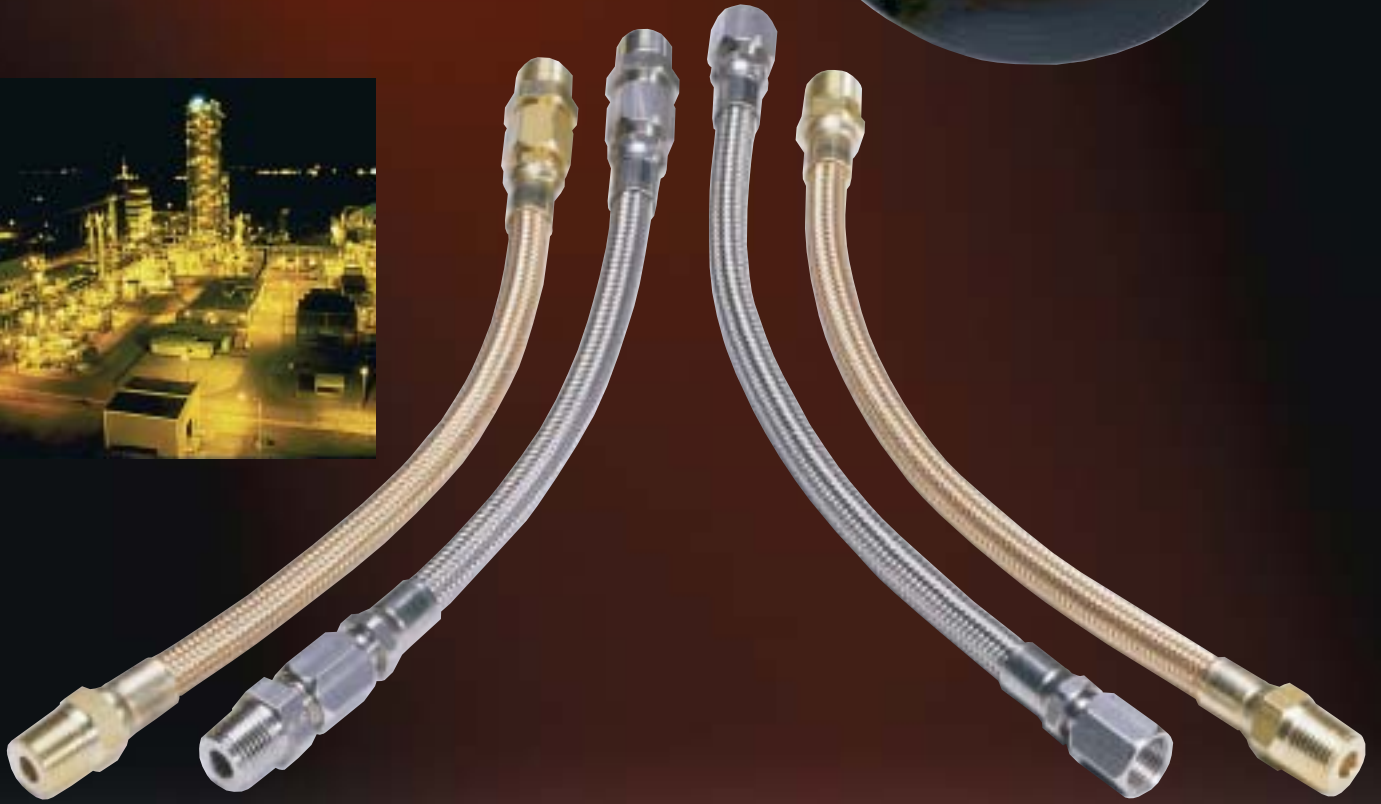

Read This Information Before Using This Catalog.

This catalog is intended as a guide in selecting the proper hose and fittings for the applications listed herein. It contains cautions, warnings, guidelines and directions for the safe and proper use of Everflex Hose. All these directions and footnotes should be read and understood before specifying or using any of these hoses.

Symbols, boxes, boldface type, etc. are used to call attention to these instructions. Be sure to read and understand them before proceeding further with this information.

 This symbol is used when personal injury is possible.

 **WARNING:** A failure of teflon hose in service can result in personal injury, death or damage of property.

Do not use Teflon hose at temperatures or pressures above those recommended by the manufacturer. All operators must be thoroughly trained in the care and use of this hose and must at all times wear protective clothing. A hose or system failure could cause the release of a poisonous, corrosive or flammable material.

 **WARNING:** These hoses can be used to convey hazardous chemicals, steam, hot liquids or other dangerous materials which can cause death, serious injury including burns, pressure wounds or chemical exposure if released accidentally. They should, therefore, only be handled or worked on by personnel properly trained in the safe handling of the materials or chemicals being conveyed in the hoses.

 **WARNING:** Selection of the proper end fittings for the hose end application is essential to the proper operation and safe use of the hose and related equipment. Inadequate attention to the selection of the end fittings for your application can result in leaking or the hose ends blowing off the hose, leading to serious personal injury, death or property damage.

The use or intermixing of fittings and hose not specifically engineered and designed for use with the Everflex equipment may result in the production of an unsafe or unreliable hose assembly. The Everflex limited warranty is contingent upon the fact that only Everflex end fittings and Everflex hose be used on Everflex assembly equipment.

In order to avoid serious bodily injury or property damage resulting from selection of the wrong end fitting, you should carefully review the information in this catalog.

CONTENTS	PAGE
APPLICATION DATA	
Safety Information	1
Steam Hose Safety Information	3
Steam Temperatures	4
Diverse and Demanding Applications	5
SMOOTH BORE HOSE OF TEFLON®	
Smooth Bore Bulk Hose	6-9
Everswage Hose Ends	10-12
Everswage Hose End Component Parts	13
Everswage Adapters	14
Conduit Shielding Fittings	14
'E' Series Crimp Hose Ends	15-20
'FA' Field Attachable Hose Ends	21
'FA' Field Attachable Hose End Component Parts	22
How to Order Everswage Hose Assemblies	23
Everswage Hose Assemblies	23-25
Everswage Laundry Series Hose Assemblies	26
Everswage Steam Iron Hose Assemblies & Adapters	27
How To Order 'E' Series Hose Assemblies	28
Smooth Bore Hose Accessories	29
CONVOLUTED HOSE	
Conv-O-Crimp Bulk Hose	30
Conv-O-Crimp Hose Ends	31-32
How To Order Conv-O-Crimp	33
ASSEMBLY EQUIPMENT & PROCEDURES	
Everswage Equipment & Tooling	34
Everswage Tooling Selector Chart	35
Everswage Assembly Procedures	36-37
'E' Series Tooling Selector Chart	38
'E' Series Crimp Assembly Procedures	39-40
Conv-O-Crimp Equipment and Tooling	41
Conv-O-Crimp Assembly Procedures	42-45
Conv-O-Crimp Fitting Locator Adjustment	46
CHEMICAL RESISTANCE CHART	
Partial List of Chemicals	47-49
WARRANTY & CLAIM INFORMATION	
Warranty	50
Claim	50

Make Your Selection With Safety In Mind

- Be sure to select a hose identified as steam hose construction.
- You must identify the type of service the steam hose is required to accomplish.
 - a) Is the hose manually handled?
 - b) What is the anticipated frequency of use?
 - c) What is the actual pressure of the steam service?
 - d) Is it subject to surges or peak pressures?
 - e) What is the temperature of the steam?
 - f) Saturated (wet) or superheated (dry) steam?
 - g) What are the external conditions in the area where the hose will be used?
- You should recognize that spillage, or accumulations of corrosive chemicals or petroleum based materials externally, can have a deteriorating effect on the hose cover.

Making Sure the Hose is Installed Properly

- Avoid extreme flexing of the hose near the coupling. If necessary, use elbows in the piping system to assure a straight line connection with the hose.
- Installing and using a shut-off valve between the steam source and the hose will maximize service life and operator safety. We Consider Such A Valve Mandatory For Safe Operation.
- The use of spring guards can relieve some of the acute flexing encountered in heavy manual handling applications.
- Provide a suitable means of storing the hose when not in use. A permanent rack or tray will minimize the damage to the hose in storage. Do not hang the hose on a hook, nail, or other device which could cut or damage the hose.

Common Sense with Steam Hose

- Provide operators with adequate safety clothing. Include gloves, rubber boots, full length protective clothing, and eye protection. The objective is to provide protection from scalding burns resulting from splash-back of steam or hot water.
- Ensure that the work area is free of tripping hazards and other clutter.
- Do not allow the hose to remain pressurized when not in service. Turning off the pressure can provide dramatic increases in steam hose service life.
- The best protection from accidents is the anticipation that they could occur.

Periodic Maintenance of Steam Hose Can Pay Big Dividends

All steam hoses are expected to wear out in time. It is important to continually be on the look-out for hose that has deteriorated to the point where it can no longer provide safe service. The following guidelines can help in that determination.

Operators should be aware of the obvious signs of trouble. They include:

- Steam leakages at the coupling ends or anywhere along the length of the hose.
- Flattened or kinked areas which have damaged the hose.

When any of the above abnormalities appear, it is good safety sense to immediately remove the hose from service. Once removed, the hose can be carefully inspected before further use.

 **WARNING:** Exposure to steam is hazardous. If not properly controlled, steam can cause serious injury, death, or damage to property. In order to avoid serious injury, death, or damage to property, you must select the proper steam hose for the given application. Also, proper installation, usage and maintenance of the steam hose you select will contribute to increased operator safety. Carefully read and understand the safety information provided on this page and the following pages.

 **WARNING:** Failure to properly follow the manufacturer's recommended procedures for the care, maintenance and storage of a particular hose may result in its failure to perform in the manner intended and may result in serious injury, death, and damage to property.

 **WARNING:** Only specially trained persons should engage in applications or testing procedures that require particular skills. Failure to do so may result in damage to the hose products or to other property and more importantly, may also result in serious injury.

Temperatures of Saturated Steam at Various Pressures

LBS. PER SQ IN. PRESSURE	DEGREES FAHRENHEIT	DEGREES CENTIGRADE	LBS. PER SQ IN. PRESSURE	DEGREES FAHRENHEIT	DEGREES CENTIGRADE
0	212.0	100.0	110	344.1	173.4
5	227.1	108.4	115	347.2	175.1
10	239.4	115.2	120	350.1	176.7
15	249.8	121.0	125	352.9	178.3
20	258.8	126.0	130	355.6	179.8
22	261.2	127.8	135	358.3	181.3
24	265.3	129.6	140	360.9	182.7
26	268.3	131.3	145	363.4	184.1
28	271.2	132.9	150	365.9	185.5
30	274.1	134.5	155	368.2	186.8
32	276.8	136.0	160	370.6	188.1
34	279.3	137.4	165	373.9	189.4
36	281.8	138.8	170	375.3	190.7
38	284.4	140.2	175	377.4	191.9
40	286.7	141.5	180	379.6	193.1
42	289.0	142.8	185	381.7	194.3
44	291.2	144.0	190	383.7	195.4
46	293.5	145.3	195	385.9	196.6
48	295.5	146.4	200	387.9	197.7
50	297.7	147.6	205	398.8	198.8
52	299.9	148.7	210	391.6	199.8
54	301.6	149.8	215	392.9	200.5
56	303.6	150.9	220	395.4	201.7
58	305.4	151.9	225	397.2	202.9
60	307.4	153.0	230	399.0	203.9
62	309.2	154.0	235	400.7	204.8
64	310.8	154.9	240	402.5	205.8
66	312.6	155.9	245	404.2	206.8
68	314.2	156.8	250	406.1	207.8
70	316.0	157.0	255	407.7	208.7
72	317.7	158.7	260	409.4	209.7
74	319.3	159.6	265	411.0	210.6
76	320.9	160.5	270	412.6	211.4
78	322.3	161.3	275	414.2	212.3
80	323.8	162.1	280	415.7	213.2
85	327.6	164.2	300	421.0	216.1
90	331.2	166.2	350	436.5	224.7
95	334.6	168.1			
100	337.8	169.9			
105	341.1	171.7			

 **WARNING** Steam heat is hotter than 212° F (boiling water) and increases in temperature as pressure increases. See safety information on page 3.

Diverse and Demanding Applications



Hose of Teflon® has excellent temperature characteristics. It works well in high ambient, fluid or gas media temperatures (+450°F). It works equally well in cryogenic applications (-65°F). Specific temperature guidelines are found on pages 6-9.

Hose of Teflon® has a broad range of chemical resistance. It is inert to most commercial chemicals, acids, alcohols, coolants, elastomers, petroleum compounds, solvents, vinyls, synthetic lubricants, and hydraulic fluids. Chemical resistance guidelines are found on pages 47-49.

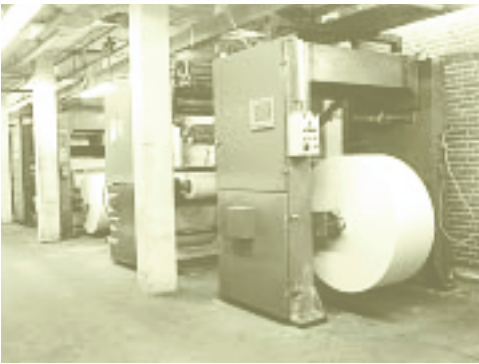

Hose of Teflon® withstands continuous flexing, vibration, or impulse.

Hose of Teflon® withstands alternating cold and heat cycling

Hose of Teflon® is compatible with steam. It absorbs no moisture hot or cold. It is easy to clean and sterilize.

Hose of Teflon® is non-contaminating. Conveyed materials, fluids, or gases will not contaminate in service.



Hose of Teflon® has high flow rates. Its low coefficient of friction with anti-stick properties insures continuous lower pressure drop during service with good pressure rating.

Hose of Teflon® resists deterioration. It is impervious to weather and can be stored for long periods of time without aging.

Hose of Teflon® has a long life expectancy when applied within its temperature and pressure rating



Hose of Teflon® handles many substances such as adhesives, asphalt, dyes, greases, glue, latex, lacquers & paints. It has no carbon build-up when used as a compressor discharge line.

Teflon® is a registered trademark of DuPont.

Smooth Bore

Hose

Everflex Smooth Bore Hose of Teflon® is specified in many of the most difficult applications in industry. The extruded tube has excellent flex life, high temperature resistance and chemical resistance. Additionally, since teflon is steam compatible and non-adhesive, Everflex hose is an excellent choice in applications requiring steam cleaning of an assembly or transfer of a highly viscous media, such as adhesives, paints or food products. The 304 stainless steel wire reinforcement/cover provides the strength necessary to carry the working pressure and the durability to withstand harsh environments. High temperature hydraulic and pneumatic systems, like those found in steel mills, foundries, transit buses and air compressors, are ideal locations to offer Everflex hose as a problem solver.

H
O
S
E

Smooth Bore 'S' Series

Hose

Everflex S Series tube is reinforced with 304 stainless steel wire. All sizes have a minimum of .040" thick extruded virgin Teflon. That is 33% more Teflon than most other manufacturers offer. The additional Teflon results in improved bend radius, kink resistance and slows permeation of gases. **Radius in inches to inside bend. Multiply bend radius by 1.25 for dynamic applications.**

Braid: Stainless Steel
Sizes: 5/32" I.D. to 1-1/8" I.D.
Temperature range: -65° F to +450° F (-54°C to +230°C)



Hose							
Catalog Number	Actual I.D. (in.)	Average O.D. (in.)	Wall Thickness (in.)	Working Pressure (psi) 72°F	Min. Burst Pressure (psi) 72°F	Min. Bend Radius	Hose Ends
S-3	5/32	.250	.040	3,500	14,000	1.0	Everswage
S-4 ♦	3/16	.320	.040	3,000	12,000	1.5	Everswage, 'FA' Series
S-5 ♦	1/4	.375	.040	3,000	12,000	2.0	Everswage, 'FA' Series
S-6	5/16	.435	.040	2,500	10,000	3.5	Everswage, 'FA' Series
S-6DW†	5/16	.545	.080	2,500	10,000	3.5	Everswage, 'DW'
S-8	13/32	.565	.043	2,000	8,000	4.5	Everswage, 'FA' Series
S-10	1/2	.656	.047	1,750	7,000	5.0	Everswage, 'FA' Series
S-12	5/8	.780	.047	1,500	6,000	6.0	Everswage, 'FA' Series
S-16	7/8	1.050	.047	1,000	4,000	9.0	Everswage, 'FA' Series
S-16Z	7/8	1.100	.047	1,250	5,000	7.3	Everswage
S-20Z	1 1/8	1.350	.050	1,000	4,000	11.0	Everswage

⚠ WARNING: These hoses can be used to convey hazardous chemicals, steam, hot liquids or other dangerous materials which can cause death, serious bodily injury including burns, pressure wounds or chemical exposure if released accidentally. They should, therefore, only be handled or worked on by personnel properly trained in the safe handling of the materials or chemicals conveyed in the hoses.

† Double wall (DW) autoclave hose.

♦ Part numbers S-4 and S-5 exceed the permeation criteria set forth by the Compressed Gas Association, E-9 Specification.

"Z" Designates a double braid of 304 stainless steel wire.

Teflon® is a registered trademark of DuPont.

Smooth Bore 'B' Series

Braid: Bronze
Sizes: 5/32" I.D. to 7/8" I.D.
Temperature range: -65° F to +400° F (-54°C to +204°C)



Hose

Catalog Number	Actual I.D. (in.)	Average O.D. (in.)	Wall Thickness (in.)	Max Work Pressure (psi) 72°F	Min. Burst Pressure (psi) 72°F	Min. Bend Radius	Hose Ends
B-3	5/32	.250	.040	1,375	5,500	1.0	Everswage
B-4	3/16	.320	.040	1,250	5,000	1.5	Everswage, 'FA' Series
B-5	1/4	.375	.040	1,125	4,500	2.0	Everswage, 'FA' Series
B-6	5/16	.435	.040	1,050	4,200	3.5	Everswage, 'FA' Series
B-8	13/32	.565	.043	1,000	4,000	4.5	Everswage, 'FA' Series
B-10	1/2	.656	.047	900	3,600	5.0	Everswage, 'FA' Series
B-12	5/8	.780	.047	750	3,000	6.0	Everswage, 'FA' Series
B-16	7/8	1.050	.047	625	2,500	9.0	Everswage, 'FA' Series

Smooth Bore 'STW' Series

Everflex STW Series tube is reinforced with 304 stainless steel wire. STW hose is available as an alternative where competitors' thin wall products are specified and S Series hose can not be substituted. **Radius in inches to inside bend. Multiply bend radius by 1.25 for dynamic applications. Note: Consult factory for SAE 100R14 specifications**

Braid: Stainless Steel
Sizes: 3/16" I.D. to 1" I.D.
Temperature range: -65° F to +450° F (-54°C to +230°C)



Hose

Catalog Number	Actual I.D. (in.)	Average O.D. (in.)	Wall Thickness (in.)	Working Pressure (psi) 72°F	Min. Burst Pressure (psi) 72°F	Min. Bend Radius	Hose Ends
S-4TW	3/16	.305	.030	3,000	12,000	2.0	Everswage, 'FA', 'E' Series
S-5TW	1/4	.375	.030	3,000	12,000	3.0	Everswage, 'FA', 'E' Series
S-6TW	5/16	.430	.030	2,500	10,000	4.0	Everswage, 'FA', 'E' Series
S-7TW	3/8	.515	.030	2,000	8,000	5.0	'E' Series
S-8TW	13/32	.535	.030	2,000	8,000	5.0	Everswage, 'FA' Series
S-10TW	1/2	.636	.030	1,750	7,000	6.5	Everswage, 'FA', 'E' Series
S-12TW	5/8	.765	.030	1,500	6,000	7.5	Everswage, 'FA' Series
S-14TW	3/4	.890	.035	1,000	4,000	8.5	'E' Series
S-16TW	7/8	1.030	.035	1,000	4,000	9.0	Everswage, 'FA' Series
S-18ZTW	1	1.215	.035	1,000	4,000	12.0	'E' Series

WARNING: These hoses can be used to convey hazardous chemicals, steam, hot liquids or other dangerous materials which can cause death, serious bodily injury including burns, pressure wounds or chemical exposure if released accidentally. They should, therefore, only be handled or worked on by personnel properly trained in the safe handling of the materials or chemicals conveyed in the hoses.

"Z" Designates a double braid of 304 stainless steel wire.

Smooth Bore 'SC' Series

Hose

SC Series hose is identical to the S series with one exception. SC hose has an internal conductive static dissipating liner that provides a path to the hose end fittings for applications where flow induced electrostatic charges can occur. **Radius in inches to inside bend. Multiply bend radius by 1.25 for dynamic applications.**

Braid: Stainless Steel
Sizes: 5/32" I.D. to 1-1/8" I.D.
Temperature range: -65° F to +450° F (-54°C to +230°C)



H
O
S
E

Hose							
Catalog Number	Actual I.D. (in.)	Average O.D. (in.)	Wall Thickness (in.)	Working Pressure (psi) 72°F	Min. Burst Pressure (psi) 72°F	Min. Bend Radius	Hose Ends
SC-3	5/32	.250	.040	3,500	14,000	1.0	Everswage
SC-4	3/16	.320	.040	3,000	12,000	1.5	Everswage, 'FA' Series
SC-5	1/4	.375	.040	3,000	12,000	2.0	Everswage, 'FA' Series
SC-6	5/16	.435	.040	2,500	10,000	3.5	Everswage, 'FA' Series
SC-8	13/32	.565	.043	2,000	8,000	4.5	Everswage, 'FA' Series
SC-10	1/2	.656	.047	1,750	7,000	5.0	Everswage, 'FA' Series
SC-12	5/8	.780	.047	1,500	6,000	6.0	Everswage, 'FA' Series
SC-16	7/8	1.050	.047	1,000	4,000	9.0	Everswage, 'FA' Series
SC-16Z	7/8	1.100	.047	1,250	5,000	7.3	Everswage
SC-20Z	1 1/8	1.350	.050	1,000	4,000	11.0	Everswage

⚠ WARNING: These hoses can be used to convey hazardous chemicals, steam, hot liquids or other dangerous materials which can cause death, serious bodily injury including burns, pressure wounds or chemical exposure if released accidentally. They should, therefore, only be handled or worked on by personnel properly trained in the safe handling of the materials or chemicals conveyed in the hoses.

"Z" Designates a double braid of 304 stainless steel wire.

Smooth Bore 'SCTW' Series

SCTW Series hose is identical to the STW Series with one exception. SCTW hose has an internal conductive static dissipating liner that provides a path to the hose end fittings for applications where flow induced electrostatic charges can occur. **Radius in inches to inside bend. Multiply bend radius by 1.25 for dynamic applications.**

Braid: Stainless Steel
Sizes: 5/32" I.D. to 1" I.D.
Temperature range: -65° F to +400° F (-54°C to +000°C)



Hose

Catalog Number	Actual I.D. (in.)	Average O.D. (in.)	Wall Thickness (in.)	Working Pressure (psi) 72°F	Min. Burst Pressure (psi) 72°F	Min. Bend Radius	Hose Ends
SC-4TW	3/16	.305	.030	3,000	12,000	2.0	Everswage, 'FA', 'E' Series
SC-5TW	1/4	.375	.030	3,000	12,000	3.0	Everswage, 'FA', 'E' Series
SC-6TW	5/16	.430	.030	2,500	10,000	4.0	Everswage, 'FA', 'E' Series
SC-7TW	3/8	.515	.030	2,000	8,000	5.0	'E' Series
SC-8TW	13/32	.535	.030	2,000	8,000	5.0	Everswage, 'FA' Series
SC-10TW	1/2	.636	.030	1,750	7,000	6.5	Everswage, 'FA', 'E' Series
SC-12TW	5/8	.765	.030	1,500	6,000	7.5	Everswage, 'FA' Series
SC-14TW	3/4	.890	.035	1,000	4,000	8.5	'E' Series
SC-16TW	7/8	1.030	.035	1,000	4,000	9.0	Everswage, 'FA' Series
SC-18ZTW	1	1.215	.035	1,000	4,000	12.0	'E' Series

WARNING: These hoses can be used to convey hazardous chemicals, steam, hot liquids or other dangerous materials which can cause death, serious bodily injury including burns, pressure wounds or chemical exposure if released accidentally. They should, therefore, only be handled or worked on by personnel properly trained in the safe handling of the materials or chemicals conveyed in the hoses.

"Z" Designates a double braid of 304 stainless steel wire.



Everswage hose ends are permanently attached to Everflex Smooth Bore Hose of Teflon® using a swaging process. The unique design of the Everswage collar allows a hose assembly fabricator to slide several collars at once on the hose. This significantly reduces the time required to fabricate an assembly. The most popular industrial fitting configurations, male Pipe (NPT) and Female JIC (SAE) Swivels, are available in 300 Series stainless steel, carbon steel, or brass. Consult factory for availability of 316 stainless steel wetted parts.

Part Number Example: B-1104-1

Male Pipe (NPT)

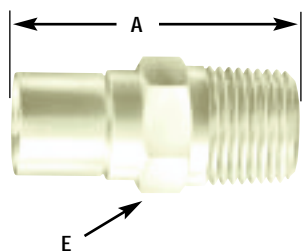

Hose Size	Hose I.D.	Part No. Pre-fix Letter	Catalog Number	Pipe Size	Thread Size	A	Hose Cut-Off Factor†	E
-3	5/32	B,S	1103	1/8	1/8-27	1.19	3/4	1/2
-4	3/16	B,C,S	1104-1	1/8	1/8-27	1.34	3/4	1/2
-4	3/16	B,C,S	1104-2	1/4	1/4-18	1.47	7/8	9/16
-5	1/4	B,C,S	1105	1/4	1/4-18	1.47	7/8	9/16
-5	1/4	B	1105-1/8	1/8	1/8	1.34	15/16	9/16
-6	5/16	B,C,S	1106-1	1/4	1/4-18	1.47	7/8	11/16
-6DW*	5/16	S	1106DW-1	1/4	1/4-18	1.53	1	11/16
-6	5/16	B,C,S	1106-2	3/8	3/8-18	1.53	15/16	11/16
-6DW*	5/16	S	1106DW-2	3/8	3/8-18	1.53	1-3/16	11/16
-6	5/16	B,S	1106-3	1/2	1/2	1.75	1-1/8	7/8
-8	13/32	B,C,S	1108-1	3/8	3/8-18	1.84	1	3/4
-8	13/32	B,C,S	1108-2	1/2	1/2-14	1.97	1-1/8	7/8
-10	1/2	B,C,S	1110	1/2	1/2-14	1.97	1-3/16	7/8
-12	5/8	B,C,S	1112	3/4	3/4-14	2.14	1-5/16	1-1/16
-16	7/8	B,C,S	1116	1	1-11.5	2.94	1-5/8	1-3/8
-16Z	7/8	B,C,S	1116Z‡	1	1-11.5	2.94	1-5/8	1-3/8
-20Z	1-1/8	B,C,S	1120Z‡	1-1/4	1-1/4-11.5	3.03	1-3/4	1-3/4

37° JIC Swivel

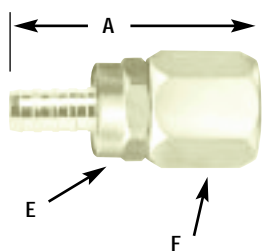

Hose Size	Hose I.D.	Part No. Pre-fix Letter	Catalog Number	Pipe Size	Thread Size	A	Hose Cut-Off Factor†	E	F
-3	5/32	B,S	1303	3/16	3/8-24	1.38	9/16		1/2
-3	5/32	B	1303-4	1/4	7/16-20	1.38	7/16	1/2	9/16
-4	3/16	B,C,S	1304	1/4	7/16-20	1.50	7/8	1/2	9/16
-5	1/4	B,C,S	1305	5/16	1/2-20	1.63	15/16	9/16	5/8
-6	5/16	B,C,S	1306	3/8	9/16-18	1.63	1	5/8	11/16
-8	13/32	B,C,S	1308	1/2	3/4-16	2.00	1-3/16	3/4	7/8
-10	5/8	B,C,S	1310	5/8	7/8-14	2.00	1-5/16	7/8	1
-12	5/8	B,C,S	1312	3/4	1-1/6-12	2.25	1-7/16	1-1/16	1-1/4
-16	7/8	B,C,S	1316	1	1-5/16-12	2.88	1-5/8	1-3/8	1-1/2
-16Z	7/8	B,C,S	1316Z‡	1	1-5/16-12	2.88	1-5/8	1-3/8	1-1/2
-20Z	1-1/8	B,C,S	1320Z‡	1-1/4	1-5/8-12	3.13	1-11/16	1-3/4	2

45° Brass Swivel

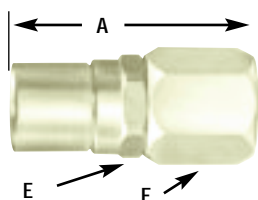

Hose Size	Hose I.D.	Catalog Number	Pipe Size	Thread Size	A	Hose Cut-Off Factor†	E	F
-4	3/16	FITT. #30	1/4	7/16-20	1.50	7/8	1/2	9/16
-5	1/4	FITT. #31	5/16	1/2-20	1.50	15/16	9/16	5/8
-6	5/16	FITT. #32▲	3/8	5/8-18	1.63	1	5/8	3/4
-8	13/32	FITT. #33	1/2	3/4-16	2.00	1-3/16	3/4	7/8
-10	1/2	FITT. #34	5/8	7/8-14	2.13	1-5/16	7/8	1
-12	5/8	FITT. #35	3/4	1-1/16-14	2.25	1-7/16	1-1/16	1-1/4

⚠ WARNING: Selection of the proper end fitting for the hose end application is essential to the proper operation and safe use of the hose and related equipment. Inadequate attention to the selection of the end fittings for your application can result in leaking or the hose end blowing off the hose, leading to serious personal injury, death or property damage.

† To determine the correct length of hose, subtract the cut-off factor for each end fitting from the overall length of assembly.

▲ Only fitting 32 has Carbon Steel nut.

‡ The 16Z, 18ZTW, and 20Z sizes have a double stainless steel wire reinforcement.

* Double wall (DW) autoclave hose.

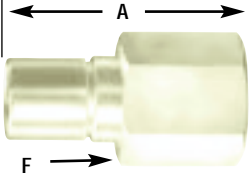
Female Pipe (NPT)		Hose Size	Hose I.D.	Part No. Pre-fix Letter	Catalog Number	Pipe Size	Thread Size	A	Hose Cut-Off Factor†	F
		-4	3/16	B	2104-1	1/8	1/8-27	1.28	11/16	9/16
		-4	3/16	B	2104-2	1/4	1/4-18	1.41	13/16	3/4
		-5	1/4	B,S	2105	1/4	1/4-18	1.41	13/16	3/4

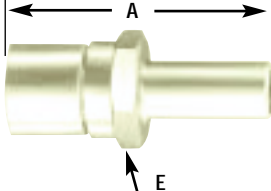
Stainless Steel Tube Stub		Hose Size	Hose I.D.	Catalog Number	Tube Size	Connector	A	Hose Cut-Off Factor†	E
		-4	3/16	STE-4-4	1/4"O.D.	0.188	1.50	1-1/8	9/16
		-5	1/4	STE-4-5	1/4"O.D.	0.203	1.50	7/8	9/16
		-6	5/16	STE-6-6	3/8"O.D.	0.266	1.63	1	11/16
		-8	13/32	STE-8-8	1/2"O.D.	0.359	2.25	1-3/8	7/8
		-12	5/8	STE-12-12	3/4"O.D.	0.578	2.38	1-1/2	1-1/16
		-16	7/8	STE-16-16	1"O.D.	0.813	3.00	1-11/16	1-3/8

Brass Laundry Flange		Hose Size	Hose I.D.	Catalog Number	Nominal I.D.	A	Hose Cut-Off Factor†
				B-6LFC	17/64	1	5/16
		(flange is plated carbon steel, copper gasket included)					

Brass Tire Mold Flange		Hose Size	Hose I.D.	Catalog Number	Nominal I.D.	A	Hose Cut-Off Factor†	E
		-12	5/8	FITT. #60	37/64	2.63	1-5/8	1-1/16
		-16	7/8	FITT. #61	37/64	3.38	2-1/8	1-3/8
		-16	7/8	FITT. #62	13/16	2.50	1-11/16	1-3/8
		(flange is plated carbon steel)						

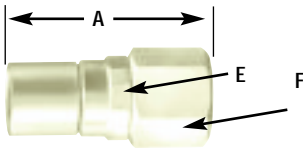
Carbon Steel Paint Spray Swivel		Hose Size	Hose I.D.	Catalog Number	Thread Size	A	Hose Cut-Off Factor†	E	F
		-5	1/4	C-5PS	1/4 NPSM	1.50	13/16	9/16	5/8

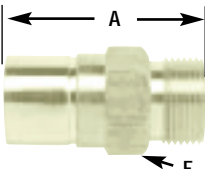
SAE Brass Male Compression		Hose Size	Hose I.D.	Catalog Number	Pipe Size	Thread Size	A	Hose Cut-Off Factor†	E
		-10	1/2	FITT. #40	5/8	13/16-18	1.75	29/32	7/8

⚠ WARNING: Selection of the proper end fitting for the hose end application is essential to the proper operation and safe use of the hose and related equipment. Inadequate attention to the selection of the end fittings for your application can result in leaking or the hose end blowing off the hose, leading to serious personal injury, death or property damage.

† To determine the correct length of hose, subtract the cut-off factor for each end fitting from the overall length of assembly.

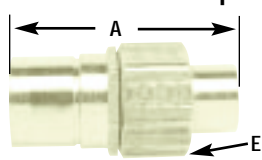
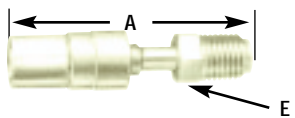
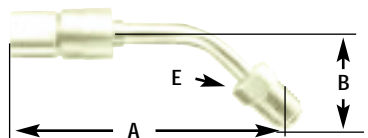
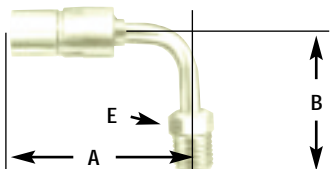
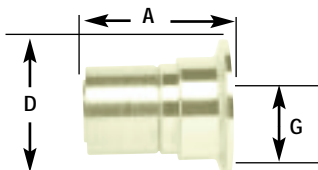
<p>SAE Brass Female Compression</p> 	<p>Hose Size</p>	<p>Hose I.D.</p>	<p>Catalog Number</p>	<p>Pipe Size</p>	<p>Thread Size</p>	<p>A</p>	<p>Hose Cut-Off Factor†</p>	<p>E</p>	
	-10	1/2	FITT. #41	5/8	13/16-18	2.00	1-3/16	15/16	
<p>Stainless Steel Power Trim, Straight</p>  <p>(316 Stainless Steel wetted Parts)</p>	<p>Hose Size</p>	<p>Hose I.D.</p>	<p>Catalog Number</p>	<p>Tube Size</p>	<p>Thread Size</p>	<p>A</p>	<p>Hose Cut-Off Factor†</p>	<p>E</p>	
	-4	3/16	PT-S-4	3/16	3/8-24	1.88	1-7/16	3/8	
<p>Stainless Steel Power Trim, 45° Elbow</p>  <p>(316 Stainless Steel wetted Parts)</p>	<p>Hose Size</p>	<p>Hose I.D.</p>	<p>Catalog Number</p>	<p>Tube Size</p>	<p>Thread Size</p>	<p>A</p>	<p>Hose Cut-Off Factor†</p>	<p>B</p>	<p>E</p>
	-4	3/16	PT-45-4	3/16	3/8-24	2.75	2	3/4	3/8
<p>Stainless Steel Power Trim, 90° Elbow</p>  <p>(316 Stainless Steel wetted Parts)</p>	<p>Hose Size</p>	<p>Hose I.D.</p>	<p>Catalog Number</p>	<p>Tube Size</p>	<p>Thread Size</p>	<p>A</p>	<p>Hose Cut-Off Factor†</p>	<p>B</p>	<p>E</p>
	-4	3/16	PT-90-4	3/16	3/8-24	2.00	1-1/2	1	3/8
<p>Sanitary Tri Clamp</p>  <p>(316 Stainless Steel wetted Parts)</p>	<p>Hose Size</p>	<p>Hose I.D.</p>	<p>Catalog Number</p>	<p>G</p>	<p>Nominal I.D.</p>	<p>A</p>	<p>Hose Cut-Off Factor†</p>	<p>D</p>	
	-10	1/2	10-S.37-316	.375	.45	1.5	.6875	.985	
	-16	7/8	16-S.87-316	.86	.81	2.0	.6875	1.984	

⚠ WARNING: Selection of the proper end fitting for the hose end application is essential to the proper operation and safe use of the hose and related equipment. Inadequate attention to the selection of the end fittings for your application can result in leaking or the hose end blowing off the hose, leading to serious personal injury, death or property damage.

†To determine the correct length of hose, subtract the cut-off factor for each end fitting from the overall length of assembly.

Male Pipe Insert		Hose I.D.	Catalog Number	Part No. Suffix Letter	Pipe Size
		3/16	NM-2-4	B,C,S	1/8
		3/16	NM-4-4	B,C,S	1/4
		1/4	NM-4-5	B,C,S	5/16
		5/16	NM-4-6	B,C,S	1/4
		5/16	NM-6-6	B,C,S	3/8
		13/32	NM-6-8	B,C,S	3/8
		13/32	NM-8-8	B,C,S	1/2
		1/2	NM-8-10	B,C,S	1/2
		5/8	NM-12-12	B,C,S	1
		7/8	NM-16-16	B,C,S	1
	1-1/8	NM-20	B,C,S	1-1/4	

Swage Collars		Hose Size	Hose I.D.	Catalog Number	Part No. Suffix Letter	JIC Size
		-4	3/16	NC-4	B,C,S	1/4
		-5	1/4	NC-5	B,C,S	5/16
		-6	5/16	NC-6	B,C,S	3/8
		-8	13/32	NC-8	B,C,S	1/2
		-10	1/2	NC-10	B,C,S	5/8
		-12	5/8	NC-12	B,C,S	3/4
		-16	7/8	NC-16	B,C,S	1
		-16	7/8	NC-16Z	B,C,S	1
		-20	1-1/8	NC-20	B,C,S	1-1/4

JIC Female Nuts		Hose Size	Hose I.D.	Catalog Number	Part No. Suffix Letter	JIC Size
		-4	3/16	NNJ-4	B,C,S	1/4
		-5	1/4	NNJ-5	B,C,S	5/16
		-6	5/16	NNJ-6	B,C,S	3/8
		-8	13/32	NNJ-8	B,C,S	1/2
		-10	1/2	NNJ-10	B,C,S	5/8
		-12	5/8	NNJ-12	B,C,S	3/4
		-16	7/8	NNJ-16	B,C,S	1
		-20	1-1/8	NNJ-20	B,C,S	1-1/4

JIC Female Insert		Hose Size	Hose I.D.	Catalog Number	Part No. Suffix Letter	JIC Size
		-4	3/16	NJ-4	B,C,S	1/4
		-5	1/4	NJ-5	B,C,S	5/16
		-6	5/16	NJ-6	B,C,S	3/8
		-8	13/32	NJ-8	B,C,S	1/2
		-10	1/2	NJ-10	B,C,S	5/8
		-12	5/8	NJ-12	B,C,S	3/4
		-16	7/8	NJ-16	B,C,S	1
		-20	1-1/8	NJ-20	B,C,S	1-1/4

JIC Female Short Collars		Hose Size	Hose I.D.	Catalog Number	Part No. Suffix Letter	JIC Size
		-4	3/16	NJC-4	B,C,S	1/4
		-5	1/4	NJC-5	B,C,S	5/16
		-6	5/16	NJC-6	B,C,S	3/8
		-8	13/32	NJC-8	B,C,S	1/2
		-10	1/2	NJC-10	B,C,S	5/8
		-12	5/8	NJC-12	B,C,S	3/4
		-16	7/8	NJC-16	B,C,S	1
		-20	1-1/8	NJC-20	B,C,S	1-1/4

⚠ WARNING: Selection of the proper end fitting for the hose end application is essential to the proper operation and safe use of the hose and related equipment. Inadequate attention to the selection of the end fittings for your application can result in leaking or the hose end blowing off the hose, leading to serious personal injury, death or property damage.

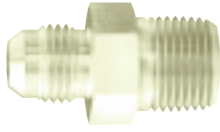
Male Pipe (NPT)	Hose Size	Hose I.D.	Part No. Pre-Fix Letter	Catalog Number	Pipe Thread (NTP)	JIC Thread
		-4	3/16	B,C,S	1004-1	1/8-27
-4		3/16	B,C,S	1004-2	1/4-18	7/16-20
-5		1/4	B,C,S	1005	1/4-18	1/2-20
-6		5/16	B,C,S	1006-1	1/4-18	9/16-18
-6		5/16	B,C,S	1006-2	3/8-18	9/16-18
-8		13/32	B,C,S	1008-1	3/8-18	3/4-16
-8		13/32	B,C,S	1008-2	1/2-14	7/8-14
-10		1/2	B,C,S	1010	1/2-14	7/8-14
-12		5/8	B,C,S	1012	3/4-14	1-1/16-12
-16		7/8	B,C,S	1016	1-11.5	1-5/16-12
-20Z*		1-1/8	B,C,S	1020	1 1/4-11.5	1-5/8-12

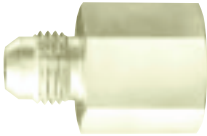
Female Pipe (NPT)	Hose Size	Hose I.D.	Part No. Pre-Fix Letter	Catalog Number	Pipe Thread (NTP)	JIC Thread
		-4	3/16	B,C,S	1004F-1	1/8-27
-4		3/16	B,C,S	1004F-2	1/4-18	7/16-20
-5		1/4	B,C,S	1005F	1/4-18	1/2-20
-6		5/16	B,C,S	1006F-1	1/4-18	9/16-18
-6		5/16	B,C,S	1006F-2	3/8-18	9/16-18
-8		13/32	B,C,S	1008F-1	3/8-18	3/4-16
-8		13/32	B,C,S	1008F-2	1/2-14	3/4-16
-10		1/2	B,C,S	1010F	1/2-14	7/8-14
-12		5/8	B,C,S	1012F	3/4-14	1-1/16-12
-16		7/8	B,C,S	1016F	1-11.5	1-5/16-12

Everswage Fittings For Use As Conduit Shielding

Everswage Fitting	Hose Size	Hose I.D.	Pre-fix Letter	Catalog Number	Insert Catalog Number	Collar Catalog Number	A	Hose Cut-Off Factor†
		6TW	5/16	B	BE-5/16	BE-5/16-I	BE-5/16-C	0.63
6TW		5/16	S	SE-5/16	SE-5/16-I	SE-5/16-C	0.63	0.25
12TW		5/8	B	BE-12	BE-12-I	BE-12C	0.75	11/32
12TW		5/8	S	SE-12			0.75	11/32

⚠ WARNING: Selection of the proper end fitting for the hose end application is essential to the proper operation and safe use of the hose and related equipment. Inadequate attention to the selection of the end fittings for your application can result in leaking or the hose end blowing off the hose, leading to serious personal injury, death or property damage.

†To determine the correct length of hose, subtract the cut-off factor for each end fitting from the overall length of assembly.

'E' Series - Crimp

E Series hose ends are permanently attached to Everflex Smooth Bore Hose of Teflon® using a crimping process. These one-piece hose ends eliminate the need for handling inserts and collars separately which reduces assembly fabrication time. The wide variety of carbon steel end configurations, including 45 and 90 degree elbows, open opportunities in applications where hose assembly routing space is very tight, such as transit buses and many high temperature hydraulic setups. 'E' SERIES FITTINGS ARE ONLY AVAILABLE FOR SPECIFIC SIZES OF 'STW' AND 'SCTW' SERIES HOSE. Reference pg. 38 for Tool Selection Information.

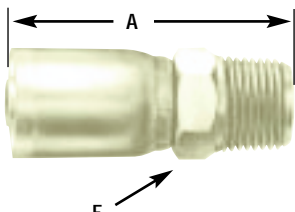
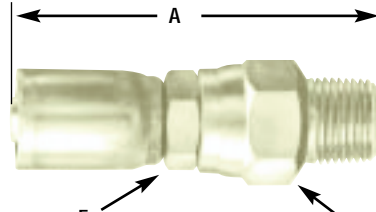
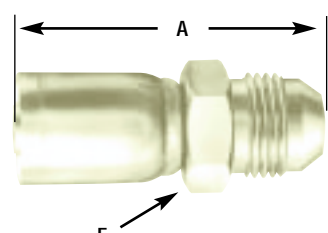
Male Pipe Rigid		Hose Size	Hose I.D.	Catalog Number	Pipe Size	Thread Size	A	Hose Cut-Off Factor†	Hole Dia.	Hex E	
		-4TW	3/16	03E-102	1/8	1/8-27	1.58	3/4	.09	7/16	
		-4TW	3/16	03E-104	1/4	1/4-18	1.83	1	.09	9/16	
		-5TW	1/4	04E-102	1/8	1/8-27	1.61	7/8	.16	7/16	
		-5TW	1/4	04E-104	1/4	1/4-18	1.79	1	.16	9/16	
		-5TW	1/4	04E-106	3/8	3/8-18	1.83	1	.16	11/16	
		-6TW	5/16	05E-104	1/4	1/4-18	1.87	1	.22	9/16	
		-6TW	5/16	05E-106	3/8	3/8-18	1.89	1	.22	11/16	
		-7TW	3/8	06E-104	1/4	1/4-18	1.89	1	.27	9/16	
		-7TW	3/8	06E-106	3/8	3/8-18	1.92	1	.27	11/16	
		-7TW	3/8	06E-108	1/2	1/2-14	2.17	1-1/4	.27	7/8	
		-10TW	1/2	08E-106	3/8	3/8-18	2.02	1	.38	3/4	
		-10TW	1/2	08E-108	1/2	1/2-14	2.27	1-1/4	.38	7/8	
		-14TW	3/4	12E-112	3/4	3/4-14	2.51	1-5/16	.61	1-1/16	
		-18ZTW	1	16E-116	1	1-11-1/2	2.95	1-5/8	.84	1-3/8	
Male Pipe Swivel		Hose Size	Hose I.D.	Catalog Number	Pipe Size	Thread Size	A	Hose Cut-Off Factor†	Hole Dia.	Hex E	Hex F
 <p>(not for temperatures above 275°F)</p>		-5TW	1/4	04E-J04	1/4	1/4-18	2.68	1-7/8	.16	5/8	13/16
		-6TW	5/16	05E-J04	1/4	1/4-18	2.74	1-7/8	.22	5/8	13/16
		-7TW	3/8	06E-J06	3/8	3/8-18	2.79	1-13/16	.27	11/16	7/8
		-10TW	1/2	08E-J08	1/2	1/2-14	3.03	2-1/16	.38	3/4	7/8
		-14TW	3/8	12E-J12	3/4	3/4-14	3.73	2-9/16	.61	1-1/4	1-1/4
SAE 37° (JIC) Male Rigid		Hose I.D.	Hose Size	Catalog Number	Tube Size	Thread Size	A	Hose Cut-Off Factor†	Hole Dia.	Hex E	
		-5TW	1/4	04E-504	1/4	7/16-20	1.78	15/16	.16	1/2	
		-5TW	1/4	04E-505	5/16	1/2-20	1.78	15/16	.16	9/16	
		-5TW	1/4	04E-506	3/8	9/16-18	1.82	1	.16	5/8	
		-6TW	5/16	05E-505	5/16	1/2-20	1.86	1	.22	9/16	
		-7TW	3/8	06E-506	3/8	9/16-18	1.92	1	.27	5/8	
		-7TW	3/8	06E-508	1/2	3/4-16	2.08	13/16	.27	13/16	
		-10TW	1/2	08E-508	1/2	3/4-16	2.18	13/16	.38	13/16	
		-10TW	1/2	08E-510	5/8	7/8-14	2.31	1-1/4	.38	15/16	
		-14TW	3/4	12E-512	3/4	1-1/16-12	2.63	1-7/16	.61	1-1/8	
		-18ZTW	1	16E-516	1	1-5/16-12	2.83	1-1/2	.84	1-3/8	

⚠ WARNING: Selection of the proper end fitting for the hose end application is essential to the proper operation and safe use of the hose and related equipment. Inadequate attention to the selection of the end fittings for your application can result in leaking or the hose end blowing off the hose, leading to serious personal injury, death or property damage.

† To determine the correct length of hose, subtract the cut-off factor for each end fitting from the overall length of assembly.

Teflon® is a registered trademark of DuPont

'E' Series - Crimp

Hose Ends

Inverted Male Swivel Straight		Hose Size	Hose I.D.	Catalog Number	Pipe Size	Thread Size	A	Hose Cut-Off Factor†	Hole Dia.	Hex E	Hex F
		-5TW	1/4	04E-B03	3/16	3/8-24	3.06	2-3/16	.12	7/16	3/8
		-5TW	1/4	04E-B04	1/4	7/16-24	2.44	1-5/8	.15	7/16	7/16
		-5TW	1/4	04E-B05	5/16	1/2-20	3.71	2-7/8	.21	7/16	1/2
		-7TW	3/8	06E-B05	5/16	1/2-20	2.56	1-9/16	.21	9/16	1/2
		-7TW	3/8	06E-B06	3/8	5/8-18	2.18	1-13/16	.24	5/8	5/8
		-10TW	1/2	08E-B08	1/2	3/4-18	3.14	2-1/16	.33	3/4	3/4
Air Brake Connection - Tube		Hose Size	Hose I.D.	Catalog Number	Pipe Size	Thread Size	A	Hose Cut-Off Factor†	Hole Dia.	Hex E	
		-10TW	1/2	08E-Y58	1/2	11/16-20	2.12	1-1/16	.38	3/4	
		-10TW	1/2	08E-Y60	5/8	13/16-18	2.18	1-1/8	.38	7/8	
		-14TW	3/4	12E-Y60	5/8	13/16-18	2.33	1-1/8	.61	1	
		-14TW	3/4	12E-Y62	3/4	1-18	2.40	1-3/16	.61	1	
Flareless Tube Rigid		Hose Size	Hose I.D.	Catalog Number	Pipe Size	Thread Size	A	Hose Cut-Off Factor†	Hole Dia.	Hex E	Hex F
		-6TW	5/16	05E-756	3/8	9/16-18	1.88	1	.22	5/8	11/16
		-7TW	3/8	06E-755	5/16	1/2-20	1.78	7/8	.23	9/16	5/8
		-7TW	3/8	06E-756	3/8	9/16-18	1.82	15/16	.27	5/8	11/16
		-10TW	1/2	08E-758	1/2	3/4-16	2.08	1-1/16	.38	13/16	7/8
SAE 37° (JIC) Female Swivel		Hose Size	Hose I.D.	Catalog Number	Pipe Size	Thread Size	A	Hose Cut-Off Factor†	Hole Dia.	Hex E	Hex F
		-4TW	3/16	03E-604 ¹	1/4	7/16-20	1.89	1-1/32	.09	7/16	9/16
		-5TW	1/4	04E-604 ¹	1/4	7/16-20	1.92	1-1/8	.16	7/16	9/16
		-5TW	1/4	04E-605 ¹	5/16	1/2-20	2.00	1-3/16	.16	1/2	5/8
		-5TW	1/4	04E-606 ¹	3/8	9/16-18	2.05	1-1/4	.16	9/16	11/16
		-6TW	5/16	05E-605 ¹	5/16	1/2-20	2.07	1-3/16	.22	1/2	5/8
		-6TW	5/16	05E-406 ²	3/8	5/8-18	2.06	1-1/8	.22	9/16	3/4
		-6TW	5/16	05E-606 ³	3/8	9/16-18	2.15	1-1/4	.22	9/16	11/16
		-7TW	3/8	06E-406 ²	3/8	5/8-18	2.06	1-1/8	.27	9/16	3/4
		-7TW	3/8	06E-606 ³	3/8	9/16-18	2.19	1-1/4	.27	9/16	11/16
		-7TW	3/8	06E-608 ¹	1/2	3/4-16	2.30	1-3/8	.27	3/4	7/8
		-10TW	1/2	08E-608 ¹	1/2	3/4-16	2.45	1-1/2	.38	3/4	7/8
		-10TW	1/2	08E-610 ¹	5/8	7/8-14	2.56	1-1/2	.38	7/8	1
		-14TW	3/4	12E-412 ²	3/4	1-1/16-14	2.98	1-11/16	.61	1-1/8	1-3/8
-14TW	3/4	12E-612 ³	3/4	1-1/16-12	2.75	1-9/16	.61	1	1-1/4		
-18ZTW	1	16E-616 ³	1	1-5/16-12	3.08	1-3/4	.84	1-1/4	1-1/2		
British Standard (BSPP) 60° Cone Female Pipe Swivel		Hose Size	Hose I.D.	Catalog Number	Pipe Size	Thread Size	A	Hose Cut-Off Factor†	Hole Dia.	Hex E	Hex F
		4TW-4	3/16	03E-354	1/4	G-1/4-19*	2.01	1-1/32	.16	9/16	11/16
		5TW-5	1/4	04E-354	1/4	G-1/4-19*	1.88	1-1/32	.16	9/16	11/16
		7-TW	3/8	06E-356	3/8	G-3/8-19*	2.09	1-1/8	.27	3/4	7/8
		7-TW	3/8	06E-358	1/2	G-1/2-14*	2.47	1-1/2	.27	13/16	1
		10-TW	1/2	08E-358	1/2	G-1/2-14*	2.56	1-1/2	.39	13/16	1
		10-TW	1/2	08E-360	5/8	G-5/8-14*	2.70	1-21/32	.39	7/8	1-3/16
		14-TW	3/4	12E-362	3/4	G-3/4-14*	2.94	19/32	.61	1	1-1/4
		18ZTW	1	16E-366	1	G-1-11*	3.38	2-1/32	.84	1-1/4	1-1/2

⚠ WARNING: Selection of the proper end fitting for the hose end application is essential to the proper operation and safe use of the hose and related equipment. Inadequate attention to the selection of the end fittings for your application can result in leaking or the hose end blowing off the hose, leading to serious personal injury, death or property damage.

† To determine the correct length of hose, subtract the cut-off factor for each end fitting from the overall length of assembly.

1- Swivel nuts are universal- Both SAE 45° and JIC 37° connections, 2- SAE 45° flare connection only,

3- JIC 37° flare connection only

* G in thread size is ISO designation for parallel Thread.

EVERFLEX[®]
ISO 9001 CERTIFIED

HOSE ENDS

'E' Series - Crimp

Female Swivel JIS 30° Flare		Hose Size	Hose I.D.	Catalog Number	Tube Size	Thread Size	A	Hose Cut-Off Factor†	Hole Dia.	Hex E	Hex F
		-5TW	1/4	04E-04L	1/4	1/4-19	1.83	1	.16	9/16	3/4
		-7TW	3/8	06E-06L	3/8	3/8-19	2.07	1-1/8	.27	11/16	7/8
		-10TW	1/2	08E-08L	1/2	1/2-14	2.03	1-1/4	.39	13/16	1-1/16
		-14TW	3/4	12E-12L	3/4	3/4-14	2.75	1-17/32	.61	1	1-5/16
		-18ZTW	1	16E-16L	1	1-11	3.05	1-23/32	.84	1-1/4	1-5/8

Female For-Seal® Swivel Straight		Hose Size	Hose I.D.	Catalog Number	Thread Size	A	Hose Cut-Off Factor†	Hole Dia.	Hex E	Hex F
		-5TW	1/4	04E-S64	9/16-18	2.14	1-15/16	.15	5/8	11/16
		-5TW	1/4	04E-S66	11/16-16	2.20	1-3/8	.16	5/8	13/16
		-6TW	5/16	05E-S66	11/16-16	2.28	1-3/8	.22	9/16	13/16
		-7TW	3/8	06E-S66	11/16-16	2.37	1-7/16	.24	9/16	13/16
		-7TW	3/8	06E-S68	13/16-16	2.65	1-11/16	.24	5/8	15/16
		-10TW	1/2	08E-S68	13/16-16	2.74	1-11/16	.33	3/4	15/16
		-10TW	1/2	08E-S70	1-14	2.83	1-13/16	.39	3/4	1-1/8
		-14TW	3/4	12E-S72	1-3/16-12	2.98	1-3/4	.59	1	1-3/8
		-18ZTW	1	16E-S76	1-7/16-12	3.31	2	.76	1-1/4	1-5/8

Straight Tube Brass		Hose Size	Hose I.D.	Catalog Number	Pipe Size	Thread Size	A	Hose Cut-Off Factor†	Hole Dia.	Hex E
		-10TW	1/2	08E-T58	1/2	11/16-20	2.12	1-1/16	.38	3/4
		-10TW	1/2	08E-T60	5/8	13/16-18	2.18	1-1/8	.38	7/8
		-14TW	3/4	12E-T60	5/8	13/16-18	2.33	1-1/8	.53	1
		-14TW	3/4	12E-T62	3/4	1-18	2.40	1-13/16	.61	1

Sleeve - Nut		Tube I.D.	Catalog Number Sleeve	Catalog Number Nut
		3/8	1360X6	1361X6
		1/2	1360X8	1361X8
		5/8	1360X10	1361X10
		3/4	1360X12	1361X12

Compressor Discharge Flange End - GM Bus Only		Hose Size	Hose I.D.	Catalog Number	A	Hose Cut-Off Factor†	Hole Dia.
		-14TW	3/4	12E-X92	2.64	1-3/8	.61

⚠ WARNING: Selection of the proper end fitting for the hose end application is essential to the proper operation and safe use of the hose and related equipment. Inadequate attention to the selection of the end fittings for your application can result in leaking or the hose end blowing off the hose, leading to serious personal injury, death or property damage.

†To determine the correct length of hose, subtract the cut-off factor for each end fitting from the overall length of assembly.

'E' Series - Crimp

Hose Ends

Inverted Male Swivel 45° Tube Elbow

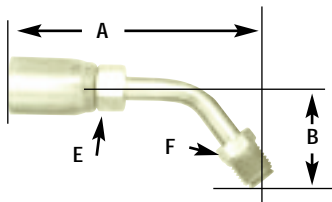

Hose Size	Hose I.D.	Catalog Number	Pipe Size	Thread Size	A	B	Hose Cut-Off Factor†	Hole Dia.	Hex E	Hex F
-5TW	1/4	04E-B43	3/16	3/8-24	2.79	.69	1-5/16	.12	7/16	3/8
-5TW	1/4	04E-B44	1/4	7/16-24	2.74	.93	1-15/16	.15	7/16	7/16
-7TW	3/8	06E-B45	5/16	1/2-20	3.37	1.14	2-7/16	.21	9/16	1/2
-7TW	3/8	06E-B46	3/8	5/8-18	3.63	1.34	2-11/16	.24	5/8	5/8
-10TW	1/2	08E-B48	1/2	3/4-18	4.32	1.58	3-1/4	.33	3/4	3/4

SAE 37° (JIC) Female Swivel 45° Tube Elbow

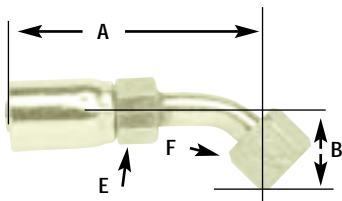

Hose Size	Hose I.D.	Catalog Number	Pipe Size	Thread Size	A	B	Hose Cut-Off Factor†	Hole Dia.	Hex E	Hex F
-5TW	1/4	04E-684 ¹	1/4	7/16-20	2.37	.33	1-9/16	.15	7/16	9/16
-5TW	1/4	04E-685 ¹	5/16	1/2-20	2.50	.36	1-5/8	.16	7/16	5/8
-6TW	5/16	05E-686 ³	3/8	9/16-18	2.65	.39	1-11/16	.22	9/16	11/16
-7TW	3/8	06E-686 ³	3/8	9/16-18	2.74	.39	1-3/4	.24	5/8	11/16
-7TW	3/8	06E-688 ¹	1/2	3/4-16	2.99	.55	2	.27	5/8	7/8
-10TW	1/2	08E-688 ¹	1/2	3/4-16	3.08	.55	2	.33	3/4	1
-10TW	1/2	08E-690 ¹	5/8	7/8-12	3.28	.63	2-1/4	.37	3/4	1
-14TW	3/4	12E-692 ³	3/4	1-1/16-12	3.69	.78	2-7/16	.58	1	1-1/4
-18ZTW	1	16E-696 ³	1	1-5/16-12	4.09	.89	2-3/4	.84	1-1/4	1-1/2

Female For-Seal® Swivel 45° Tube Elbow

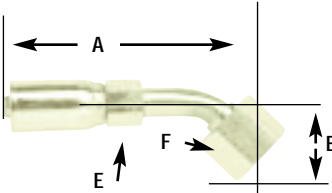

Hose Size	Tube I.D.	Catalog Number	Thread Size	A	B	Hose Cut-Off Factor†	Hole Dia.	Hex E	Hex F
-5TW	1/4	04E-L64	9/16-18	2.46	.41	1-5/8	.15	7/16	11/16
-5TW	3/8	04E-L66	11/16-16	2.69	.43	1-3/4	.15	5/8	13/16
-7TW	3/8	06E-L66	11/16-16	2.79	.43	1-13/16	.24	5/8	13/16
-10TW	1/2	08E-L68	13/16-16	3.14	.60	2-1/8	.33	3/4	15/16
-14TW	3/4	12E-L72	1-3/16-12	3.38	.83	2-5/8	.59	1	1-3/8
-18ZTW	1	16E-L76	1-7/16-12	4.31	.94	3	.76	1-1/4	1-5/8

Inverted Male Swivel 90° Tube Elbow

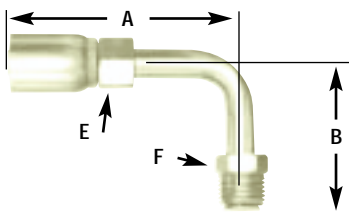

Hose Size	Hose I.D.	Catalog Number	Pipe Size	Thread Size	A	B	Hose Cut-Off Factor†	Hole Dia.	Hex E	Hex F
-5TW	1/4	04E-B63	3/16	3/8-24	2.16	1.06	1-5/16	.12	7/16	3/8
-5TW	1/4	04E-B64	1/4	7/19-24	2.18	1.36	1-5/16	.15	7/16	7/16
-7TW	3/8	06E-B65	5/16	1/2-20	2.58	1.16	1-5/8	.21	9/16	1/2
-7TW	3/8	06E-B66	3/8	5/8-18	2.92	1.97	1-15/16	.24	5/8	5/8
-10TW	1/2	08E-B68	1/2	3/4-18	3.03	2.32	1-15/16	.33	3/4	3/4

⚠ WARNING: Selection of the proper end fitting for the hose end application is essential to the proper operation and safe use of the hose and related equipment. Inadequate attention to the selection of the end fittings for your application can result in leaking or the hose end blowing off the hose, leading to serious personal injury, death or property damage.

†To determine the correct length of hose, subtract the cut-off factor for each end fitting from the overall length of assembly.

1- Swivel nuts are universal- Both SAE 45° and JIC 37° connections, 2- SAE 45° flare connection only,

3- JIC 37° flare connection only.

'E' Series - Crimp

SAE 37° (JIC) Female Swivel 90° Tube Elbow

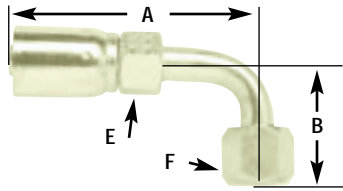

Hose Size	Hose I.D.	Catalog Number	Pipe Size	Thread Size	A	B	Hose Cut-Off Factor†	Hole Dia.	Hex E	Hex F
-5TW	1/4	04E-664 ¹	1/4	7/16-20	2.27	.68	1-7/16	.15	7/16	9/16
-5TW	1/4	04E-665 ¹	5/16	1/2-20	2.51	.77	1-5/8	.16	7/16	5/8
-6TW	5/16	05E-665 ¹	5/16	1/2-20	2.58	.77	1-5/8	.18	9/16	5/8
-6TW	5/16	05E-666 ³	3/8	9/16-18	2.63	.85	1-11/16	.22	9/16	11/16
-7TW	3/8	06E-466 ²	3/8	5/8-18	2.27	.85	1-3/4	.24	5/8	11/16
-7TW	3/8	06E-666 ³	3/8	9/16-18	2.72	.85	1-3/4	.24	5/8	11/16
-7TW	3/8	06E-668 ¹	1/2	3/4-16	2.83	1.09	1-3/4	.27	5/8	7/8
-10TW	1/2	08E-668 ¹	1/2	3/4-16	2.93	1.09	1-7/8	.33	3/4	7/8
-10TW	1/2	08E-670 ¹	5/8	7/8-14	3.54	1.23	1-7/8	.38	3/4	1
-14TW	3/4	12E-672 ³	3/4	1-1/16-12	3.56	1.82	2-5/16	.58	1	1-1/4
-18ZTW	1	16E-676 ³	1	1-5/16-12	4.06	2.14	2-5/16	.84	1-1/4	1-1/2

SAE 37° (JIC) Female Swivel Long Drop 90° Tube Elbow

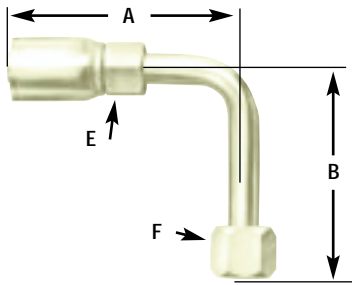

Hose Size	Hose I.D.	Catalog Number	Pipe Size	Thread Size	A	B	Hose Cut-Off Factor†	Hole Dia.	Hex E	Hex F
-5TW	1/4	04E-664 ¹	1/4	7/16-20	2.40	1.80	1-7/16	.15	7/16	9/16
-5TW	1/4	04E-645 ¹	5/16	1/2-20	2.51	1.80	1-5/8	.16	7/16	5/8
-6TW	5/16	05E-646 ³	3/8	9/16-18	2.63	2.18	1-11/16	.22	9/16	11/16
-7TW	3/8	06E-646 ³	3/8	9/16-18	2.72	2.18	1-3/4	.24	5/8	11/16
-7TW	3/8	06E-648 ¹	1/2	3/4-16	2.83	2.43	1-7/8	.27	5/8	11/16
-10TW	1/2	08E-648 ¹	1/2	3/4-16	2.92	2.43	1-7/8	.33	3/4	7/8
-10TW	1/2	08E-650 ¹	5/8	7/8-14	3.09	2.57	2-1/16	.38	3/4	1
-14TW	1/2	12E-652 ³	5/8	1-1/16-12	3.60	3.60	2-3/8	.58	1	1-1/4
-18ZTW	1	16E-656 ³	1	1-5/16-12	4.20	4.20	2-13/16	.84	1-1/4	1-1/2

Female For-Seal® Swivel Short Drop 90° Tube Elbow

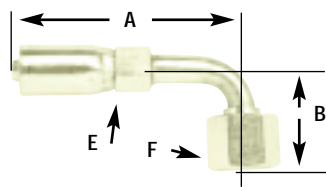

Hose Size	Hose I.D.	Catalog Number	Thread Size	A	B	Hose Cut-Off Factor†	Hole Dia.	Hex E	Hex F
-5TW	1/4	04E-A24	9/16-18	2.35	.81	1-1/2	.21	7/16	11/16
-5TW	1/4	04E-A26	11/16-16	2.54	.90	1-11/16	.16	5/8	13/16
-7TW	3/8	06E-A26	11/16-16	2.71	.90	1-3/4	.24	5/8	13/16
-7TW	3/8	06E-A28	13/16-16	2.81	1.15	1-7/8	.27	5/8	15/16
-10TW	1/2	08E-A28	13/16-16	2.90	1.15	1-7/8	.33	3/4	15/16
-12TW	3/4	12E-A32	1-3/16-12	3.70	1.88	2-1/2	.59	1	1-3/8
-18ZTW	1	16E-A36	1-7/16-12	4.11	2.21	2-3/4	.76	1-1/4	1-5/8

⚠ WARNING: Selection of the proper end fitting for the hose end application is essential to the proper operation and safe use of the hose and related equipment. Inadequate attention to the selection of the end fittings for your application can result in leaking or the hose end blowing off the hose, leading to serious personal injury, death or property damage.

† To determine the correct length of hose, subtract the cut-off factor for each end fitting from the overall length of assembly.

1- Swivel nuts are universal- Both SAE 45° and JIC 37° connections, 2- SAE 45° flare connection only, 3- JIC 37° flare connection only.

'E' Series - Crimp

Hose Ends

Female For-Seal® Swivel Long Drop 90° Tube Elbow

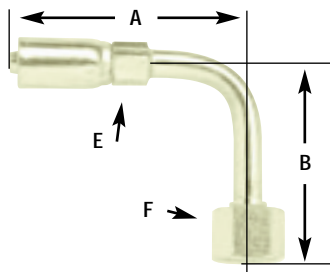

Hose Size	Hose I.D.	Catalog Number	Thread Size	A	B	Hose Cut-Off Factor†	Hole Dia.	Hex E	Hex F
-5TW	1/4	04E-A64	9/16-18	2.41	1.80	1-9/16	.21	7/16	11/16
-6TW	5/16	05E-A66	11/16-18	2.73	2.12	1-13/16	.22	9/16	13/16
-7TW	3/8	06E-A66	11/16-16	2.82	2.21	1-7/8	.24	5/8	13/16
-7TW	3/8	06E-A68	13/16-16	2.80	2.50	1-7/8	.27	5/8	15/16
-10TW	1/2	08E-A68	13/16-16	2.89	2.50	1-7/8	.33	3/4	15/16

British Standard (BSPP) 60° Cone Female Pipe Swivel 90° Elbow

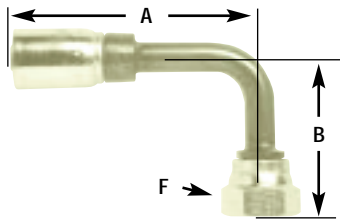

Hose Size	Hose I.D.	Catalog Number	BSPP Pipe Size	Thread Size	A	B	Hose Cut-Off Factor†	Hole Dia.	Hex E	Hex F
-5TW	1/4	04E-74P	1/4	G-1/4-19*	2.81	1.45	1-13/16	.16	7/16	11/16
-7TW	3/8	06E-76P	3/8	G-3/8-19*	2.96	1.67	2	.27	5/8	7/8
-10TW	1/2	08E-78P	1/2	G-1/2-14*	2.95	1.73	1-29/32	.37	3/4	1-1/4
-14TW	3/4	12E-82P	3/4	G-3/4-14*	3.83	2.43	1-19/32	.61	1	1-1/4

⚠ WARNING: Selection of the proper end fitting for the hose end application is essential to the proper operation and safe use of the hose and related equipment. Inadequate attention to the selection of the end fittings for your application can result in leaking or the hose end blowing off the hose, leading to serious personal injury, death or property damage.

†To determine the correct length of hose, subtract the cut-off factor for each end fitting from the overall length of assembly.
 • G in thread size is ISO designation for parallel Thread.

H
O
S
E
E
N
D
S

'FA' Series - Field Attachable



FA series hose ends are attached to Everflex Smooth Bore Hose of Teflon® using only common bench tools. This convenience allows a small user the ability to fabricate an assembly without investing in a press, pump and dies. Common industrial configurations are available with brass inserts, brass ferrules, carbon steel back nuts and carbon steel swivel nuts. These can be attached to 'S', 'SC', 'B', 'STW', and 'SCTW' Series hose.

Male Pipe

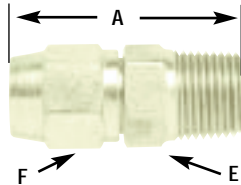

Hose Size	Hose I.D.	Catalog Number	Pipe Size	Thread Size	A	Hose Cut-Off Factor†	E	F
S,SC,B Series Hose								
-4	3/16	F4-102-B	1/8	1/8-27	1.355	.937	9/16	9/16
-4	3/16	F4-104-B	1/4	1/4-18	1.542	1.125	9/16	9/16
-5	1/4	F5-104-B	1/4	1/4-18	1.542	1.125	5/8	5/8
-6	5/16	F6-104-B	1/4	1/4-18	1.542	1.125	11/16	11/16
-6	5/16	F6-106-B	3/8	3/8-18	1.605	1.187	11/16	11/16
-8	13/32	F8-106-B	3/8	3/8-18	1.705	1.250	7/8	7/8
-8	13/32	F8-108-B	1/2	1/2-14	1.892	1.437	7/8	7/8
-10	1/2	F10-108-B	1/2	1/2-14	1.983	1.500	1	1
-12	5/8	F12-112-B	3/4	3/4-14	2.156	1.625	1-1/8	1-1/8
-16	7/8	F16-116-B	1	1-11.5	2.538	2.000	1-3/8	1-3/8
STW,SCTW Series Hose								
-4TW	3/16	F4T-102-B	1/8	1/8-27	1.355	.937	9/16	9/16
-4TW	3/16	F4T-104-B	1/4	1/4-18	1.542	1.125	9/16	9/16
-5TW	1/4	F5T-104-B	1/4	1/4-18	1.542	1.125	5/8	5/8
-6TW	5/16	F6T-104-B	1/4	1/4-18	1.542	1.125	11/16	11/16
-6TW	5/16	F6T-106-B	3/8	3/8-18	1.605	1.187	11/16	11/16
-8TW	13/32	F8T-106-B	3/8	3/8-18	1.705	1.250	7/8	7/8
-8TW	13/32	F8T-108-B	1/2	1/2-14	1.892	1.437	7/8	7/8
-10TW	1/2	F10T-108-B	1/2	1/2-14	1.983	1.500	1	1
-12TW	5/8	F12T-112-B	3/4	3/4-14	2.156	1.625	1-1/8	1-1/8
-16TW	7/8	F16T-116-B	1	1-11.5	2.538	2.000	1-3/8	1-3/8

37° JIC (SAE) Female Swivel

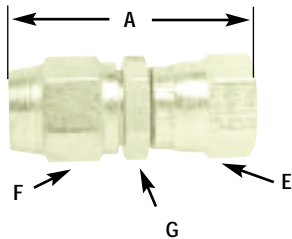

Hose Size	Hose I.D.	Catalog Number	Thread Size	A	Hose Cut-Off Factor†	E	F	G
S,SC,B Series Hose								
-4	3/16	F4-604-B ¹	7/16-20	1.570	.812	9/16	9/16	9/16
-5	1/4	F5-605-B ¹	1/2-20	1.612	.875	5/8	5/8	5/8
-6	5/16	F6-406-B ²	5/8-18	1.608	.812	3/4	11/16	11/16
-6	5/16	F6-606-B ³	9/16-18	1.700	.937	11/16	11/16	11/16
-8	13/32	F8-608-B ¹	3/4-16	1.900	1.000	7/8	7/8	7/8
-10	13/32	F10-610-B ¹	7/8-14	2.065	1.062	1	1	1
-12	5/8	F12-412-B ²	1-1/16-14	2.225	1.250	1-1/4	1-1/8	1-1/8
-12	1/2	F12-612-B ³	1-1/16-12	2.225	1.187	1-1/4	1-1/8	1-1/8
-16	7/8	F16-616-B ³	1-5/16-12	2.437	1.375	1-1/2	1-3/8	1-3/8
STW,SCTW Series Hose								
-4TW	3/16	F4T-604-B ¹	7/16-20	1.570	.812	9/16	9/16	9/16
-5TW	1/4	F5T-605-B ¹	1/2-20	1.612	.875	5/8	5/8	5/8
-6TW	5/16	F6T-406-B ²	5/8-18	1.608	.812	3/4	11/16	11/16
-6TW	5/16	F6T-606-B ³	9/16-18	1.700	.937	11/16	11/16	11/16
-8TW	13/32	F8T-608-B ¹	3/4-16	1.900	1.000	7/8	7/8	7/8
-10TW	13/32	F10T-610-B ¹	7/8-14	2.065	1.062	1	1	1
-12TW	5/8	F12T-412-B ²	1-1/16-14	2.225	1.250	1-1/4	1-1/8	1-1/8
-12TW	1/2	F12T-612-B ³	1-1/16-12	2.225	1.187	1-1/4	1-1/8	1-1/8
-16TW	7/8	F16T-616-B ³	1-5/16-12	2.437	1.375	1-1/2	1-3/8	1-3/8

⚠ WARNING: Selection of the proper end fitting for the hose end application is essential to the proper operation and safe use of the hose and related equipment. Inadequate attention to the selection of the end fittings for your application can result in leaking or the hose end blowing off the hose, leading to serious personal injury, death or property damage.



† To determine the correct length of hose, subtract the cut-off factor for each end fitting from the overall length of assembly.

1- Swivel nuts are universal- Both SAE 45° and JIC 37° connections, 2- SAE 45° flare connection only, 3- JIC 37° flare connection only.

Teflon® is a registered trademark of DuPont.

'FA' Series - Field Attachable

Components

Replacement Ferrules	Hose Size	Hose I.D.	Catalog Number
	S, SC, B Series Hose		
	-04	3/16	PRF-4-B
	-05	1/4	PRF-5-B
	-06	5/16	PRF-6-B
	-08	3/32	PRF-8-B
	-10	1/2	PRF-10-B
	-12	5/8	PRF-12-B
	-16	7/8	PRF-16-B
	STW, SCTW Series Hose		
	-04	3/16	PRF-4T-B
	-05	1/4	PRF-5T-B
	-06	5/16	PRF-6T-B
	-08	3/32	PRF-8T-B
	-10	1/2	PRF-10T-B
	-12	5/8	PRF-12T-B
	-16	7/8	PRF-16T-B
Replacement Back Nuts	Hose Size	Hose I.D.	Catalog Number
	S, SC, B, STW, SCTW Series Hose		
	-04	3/16	PRN-4-CZ
	-05	1/4	PRN-5-CZ
	-06	5/16	PRN-6-CZ
	-08	3/32	PRN-8-CZ
	-10	1/2	PRN-10-CZ
	-12	5/8	PRN-12-CZ
	-16	7/8	PRN-16-CZ

⚠ WARNING: Selection of the proper end fitting for the hose end application is essential to the proper operation and safe use of the hose and related equipment. Inadequate attention to the selection of the end fittings for your application can result in leaking or the hose end blowing off the hose, leading to serious personal injury, death or property damage.

HOSE ENDS

Everswage Smooth Bore Hose of Teflon® assemblies can be acquired from an authorized Everflex distributor or the Everflex Factory. Popular configurations of these reliable, cosmetically appealing assemblies are shown here. However, any combination of fittings shown on pages 22-25 are available. Consult factory for assembly part numbers not shown here. Everflex Smooth Bore Hose of Teflon® provides the flexibility and durability needed in the most difficult installations. The innercore of Teflon® is non-aging and has long flex-life. The stainless steel braid and all brass end connections offer the integrity required in tough steam press service applications.

OPERATING TEMPERATURE: -65° F- +450° F
OPERATING PRESSURE: Steam heat is hotter than 212° F

How to Order Assemblies:

* To order Everswage Hose Assemblies, please provide the following information.

1. Letter Prefix
2. Assembly Number from Tables Below
3. Length in Feet or Inches as Desired

ASSEMBLY LENGTH TOLERANCES:

Assemblies up to 18" ± 1/8"
 Assemblies up to 18"-36" ± 1/4"
 Assemblies up to 18"-50" ± 1/2"
 Assemblies 50" and up ± 1% of total length

Letter Prefix:

- B- Consult factory for part numbers
- E- S.S. Braid/ Brass Fittings
- C- S.S. Braid/ Carbon Steel Fittings
- S- S.S. Braid/ Stainless Steel Fittings

EXAMPLE:

E-905-82 inches
 (S.S. Braided -5 hose with 1/2-20 Brass JIC Swivel each end- 82 inches seat to seat.

Assembly Number		
Prefix Letter	Assembly No.	Suffix Hose Length (in inches)
—	304	—
—	306	—

NOTE: JIC assemblies are measured from seat to seat. All others measured overall length.

JIC Swivel to JIC Swivel

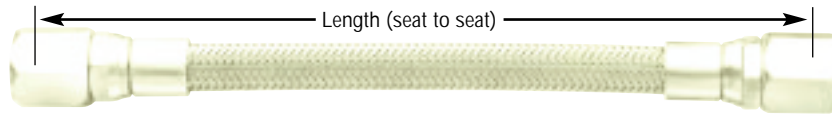

Hose Size	Hose I.D. (in)	Pre-fix Letter	Assembly Number	Thread Size	Hose Size	Hose I.D. (in)	Pre-fix Letter	Assembly Number	Thread Size
-3	5/32	E,S	903	3/8-24	-10	1/2	B,E,C,S	910	7/8-14
-4	3/16	B,E,C,S	904	7/16-20	-12	5/8	B,E,C,S	912	1 1/16-12
-5	1/4	B,E,C,S	905	1/2-20	-16	7/8	B,E,C,S	916	1 5/16-12
-6	5/16	B,E,C,S	906	9/16-20	-16Z†	7/8	B,E,C,S	916Z†	1 5/16-12
-8	13/32	B,E,C,S	908	3/4-16	-20Z†	1 1/8	B,E,C,S	920Z†	1 5/8-12

Male Pipe to Male Pipe (NPT)

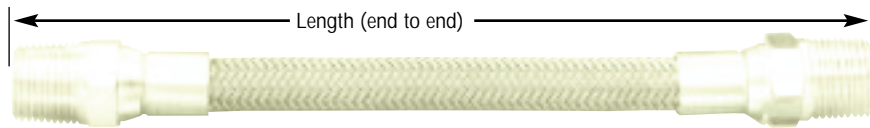

Hose Size	Hose I.D. (in)	Pre-fix Letter	Assembly Number	Thread Size	Hose Size	Hose I.D. (in)	Pre-fix Letter	Assembly Number	Thread Size
-3	5/32	E,S	303	1/8-27	-8	13/32	B,E,C,S	408	1/2-14
-4	3/16	B,E,C,S	304	1/8-27	-10	1/2	B,E,C,S	310	1/2-14
-4	3/16	B,E,C,S	404	1/4-18	-12	5/8	B,E,C,S	312	3/4-14
-5	1/4	B,E,C,S	305	1/4-18	-16	7/8	B,E,C,S	316	1-11.5
-6	5/16	B,E,C,S	306	1/4-18	-16Z†	7/8	B,E,C,S	316Z†	1-11.5
-6	5/16	B,E,C,S	406	3/8-18	-20Z†	1 1/8	B,E,C,S	320Z†	1 1/4-11.5
-8	13/32	B,E,C,S	308	3/8-18					

⚠ WARNING: These hoses can be used to convey hazardous chemicals, steam, hot liquids or other dangerous materials which can cause death, serious bodily injury including burns, pressure wounds or chemical exposure if released accidentally. They should, therefore, only be handled or worked on by personnel properly trained in the safe handling of the materials or chemicals conveyed in the hoses.

† The 16Z, and 20Z sizes have a double stainless steel wire reinforcement.

Teflon® is a registered trademark of DuPont

Everswage™ Smooth Bore

Hose Assembly
Bore

Male Pipe to
JIC Swivel

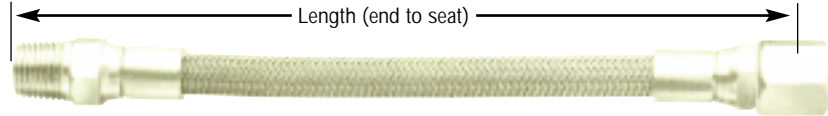

Hose Size	Hose I.D. (in)	Pre-fix Letter	Assembly Number	Thread Size	Hose Size	Hose I.D. (in)	Pre-fix Letter	Assembly Number	Thread Size
-3	5/32	E,S	103	1/8-27 to 3/8-24	-8	13/32	B,E,C,S	208	1/2-14 to 3/4-16
-4	3/16	B,E,C,S	104	1/8-27 to 7/16-20	-10	1/2	B,E,C,S	110	1/2-14 to 7/8-14
-4	3/16	B,E,C,S	204	1/4-18 to 7/16-20	-12	5/8	B,E,C,S	112	3/4-14 to 11/16-12
-5	1/4	B,E,C,S	105	1/4-18 to 1/2-20	-16	7/8	B,E,C,S	116	1-11.5 to 1 5/16-12
-6	5/16	B,E,C,S	106	1/4-18 to 9/16-18	-16Z†	7/8	B,E,C,S	116Z†	1-11.5 to 1 5/16-12
-6	5/16	B,E,C,S	206	3/8-18 to 9/16-18	-20Z†	1 1/8	B,E,C,S	120Z†	1 1/4-11.5 to 1 5/8-12
-8	13/32	B,E,C,S	108	3/8-18 to 3/4-16					

Male Union to
Male Union (NPT)

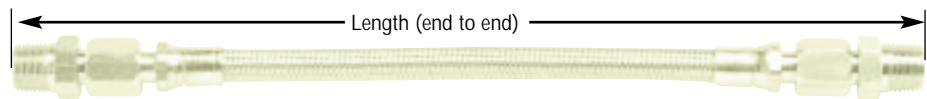

Hose Size	Hose I.D. (in)	Pre-fix Letter	Assembly Number	Thread Size	Hose Size	Hose I.D. (in)	Pre-fix Letter	Assembly Number	Thread Size
-4	3/16	B,E,C,S	504	1/8-27 to 1/8-27	-8	13/32	B,E,C,S	608	1/2-14 to 1/2-14
-4	3/16	B,E,C,S	604	1/4-18 to 1/4-18	-10	1/2	B,E,C,S	510	1/2-14 to 1/2-14
-5	1/4	B,E,C,S	505	1/4-18 to 1/4-18	-12	5/8	B,E,C,S	512	3/4-14 to 3/4-14
-6	5/16	B,E,C,S	506	1/4-18 to 1/4-18	-16	7/8	B,E,C,S	516	1-11.5 to 1-11.5
-6	5/16	B,E,C,S	606	3/8-18 to 3/8-18	-16Z†	7/8	B,E,C,S	516Z†	1-11.5 to 1-11.5
-8	13/32	B,E,C,S	508	3/8-18 to 3/8-18	-20Z†	1 1/8	B,E,C,S	520Z†	1 1/4-11.5 to 1 1/4-11.5

Male Pipe to
Male Union (NPT)

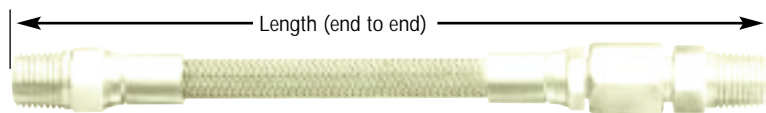

Hose Size	Hose I.D. (in)	Pre-fix Letter	Assembly Number	Thread Size	Hose Size	Hose I.D. (in)	Pre-fix Letter	Assembly Number	Thread Size
-4	3/16	B,E,C,S	704	1/8-27 to 1/8-27	-8	13/32	B,E,C,S	808	1/2-14 to 1/2-14
-4	3/16	B,E,C,S	804	1/4-18 to 1/4-18	-10	1/2	B,E,C,S	710	1/2-14 to 1/2-14
-5	1/4	B,E,C,S	705	1/4-18 to 1/4-18	-12	5/8	B,E,C,S	712	3/4-14 to 3/4-14
-6	5/16	B,E,C,S	706	1/4-18 to 1/4-18	-16	7/8	B,E,C,S	716	1-11.5 to 1-11.5
-6	5/16	B,E,C,S	806	3/8-18 to 3/8-18	-16Z†	7/8	B,E,C,S	716Z†	1-11.5 to 1-11.5
-8	13/32	B,E,C,S	708	3/8-18 to 3/8-18					

⚠ WARNING: These hoses can be used to convey hazardous chemicals, steam, hot liquids or other dangerous materials which can cause death, serious bodily injury including burns, pressure wounds or chemical exposure if released accidentally. They should, therefore, only be handled or worked on by personnel properly trained in the safe handling of the materials or chemicals conveyed in the hoses.

† The 16Z, and 20Z sizes have a double stainless steel wire reinforcement.

HOSE ASSEMBLY

Female Pipe to Female Pipe

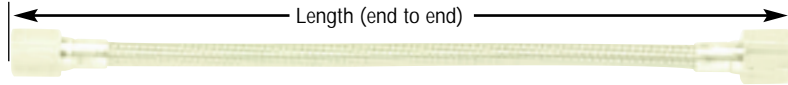

Hose Size	Hose I.D. (in)	Pre-fix Letter	Assembly Number	Thread Size
-5	1/4	B,E,S	305FF	1/4-18

Male Pipe to Female Pipe

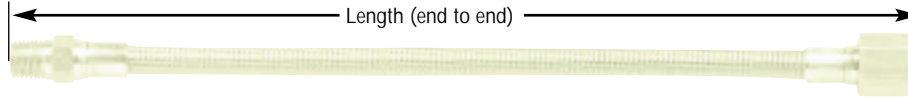

Hose Size	Hose I.D. (in)	Pre-fix Letter	Assembly Number	Thread Size
-5	1/4	B,E,S	305MF	1/4-18

Paint Spray Assembly

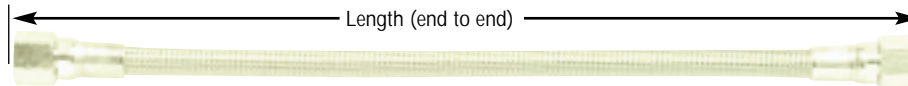

Hose Size	Hose I.D. (in)	Pre-fix Letter	Assembly Number	Thread Size
-5	1/4	C	P905	1/4-18

Stainless Steel Power Trim Assembly

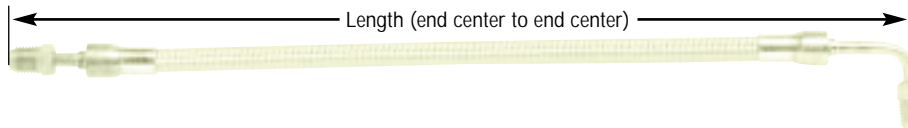

Hose Size	Hose I.D. (in)	Assembly Number	Thread Size
-4	3/16	PT-4 (straight to 90°)	3/8-24
-4	3/16	PT-4A (straight to 45°)	3/8-24
-4	3/16	PT-4B (straight to straight)	3/8-24
-4	3/16	PT-4C (45° to 45°)	3/8-24
-4	3/16	PT-4D (45° to 90°)	3/8-24
-4	3/16	PT-4E (90° to 90°)	3/8-24

⚠ WARNING: These hoses can be used to convey hazardous chemicals, steam, hot liquids or other dangerous materials which can cause death, serious bodily injury including burns, pressure wounds or chemical exposure if released accidentally. They should, therefore, only be handled or worked on by personnel properly trained in the safe handling of the materials or chemicals conveyed in the hoses.

Everswage™ Laundry Series Smooth Bore

Hose
Assembly

Male Pipe to Male Pipe M-M Series (Brass)

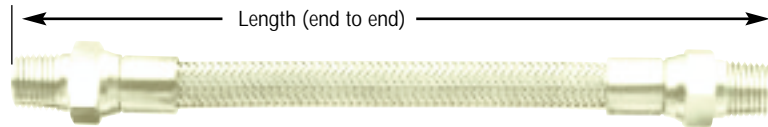

Hose Size	Hose I.D.	Assembly Part Number	Thread Size
-6TW	5/16	MM x 1/4 x "L"	1/4-18
-6TW	5/16	MM x 3/8 x "L"	3/8-18

Male Pipe to Male Union M-MU Series (Brass)

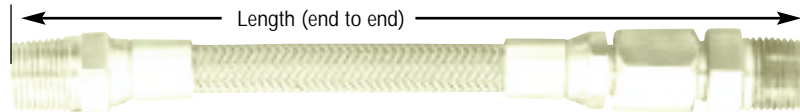

Hose Size	Hose I.D.	Assembly Part Number	Thread Size
-6TW	5/16	MMU x 1/4 x "L"	1/4-18
-6TW	5/16	MMU x 3/8 x "L"	3/8-18

Male Pipe to Two-Bolt Floating Flange M-F Series (Brass)

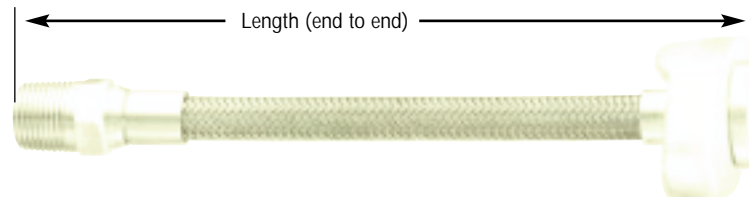

Hose Size	Hose I.D.	Assembly Part Number	Thread Size
-6TW	5/16	MF x 1/4 x "L"	1/4-18
-6TW	5/16	MF x 3/8 x "L"	3/8-18

Two Bolt Floating Flange on Each End F-F Series (Brass)

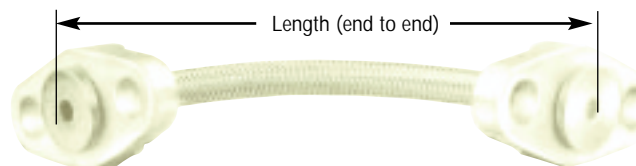

Hose Size	Hose I.D.	Assembly Part Number	Thread Size
-6	5/16	FF x 3/8 x "L"	3/8

⚠ WARNING: These hoses can be used to convey hazardous chemicals, steam, hot liquids or other dangerous materials which can cause death, serious bodily injury including burns, pressure wounds or chemical exposure if released accidentally. They should, therefore, only be handled or worked on by personnel properly trained in the safe handling of the materials or chemicals conveyed in the hoses.

H
O
S
E
A
S
S
E
M
B
L
Y

Everswage™ Steam Iron Smooth Bore

Everflex Steam Iron lines offer all the advantages of Teflon® - flexibility, durability, temperature cycling, non-aging, plus our unique outer braid construction combining stainless steel and Dacron®. The Dacron® cover/reinforcement offered on Everflex steam iron hose assemblies is resistant to steam and deterioration from moisture and provides good abrasion resistance. Everflex offers steam iron assemblies in a variety of colors, but readily available stock colors are red with a white stripe or solid green. Other features include all brass swivel end connections, choice of adapters and 3/16" hose I.D.

OPERATING TEMPERATURE: +400° F
OPERATING PRESSURE: Steam heat is hotter than 212° F

Steam Iron of Teflon®

Permanent end fittings are brass female swivel ball ends.

*To complete Part Number, replace each "X" with adapter choice as follows:

2 = 1/8" Adapter, 4 = 1/4" Adapter

Example:

3FT-DSG-P2-4 (3 ft. assembly with 1/8" male adapter one end, 1/4" male adapter other end)

**For other lengths, consult factory.

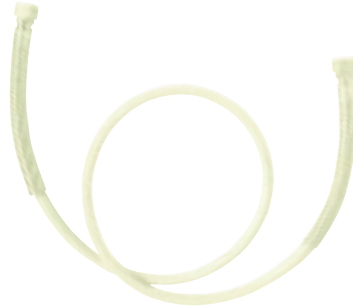

Standard Lengths**	Part Number*
3 Ft.	3FT-DSG-P"X"- "X"
4 Ft.	4FT-DSG-P"X"- "X"
5 Ft.	5FT-DSG-P"X"- "X"
6 Ft.	6FT-DSG-P"X"- "X"
8 Ft.	8FT-DSG-P"X"- "X"
10 Ft.	10FT-DSG-P"X"- "X"

Adapters

Everswage™ Steam Iron

Brass Compression Male NPT Adapter

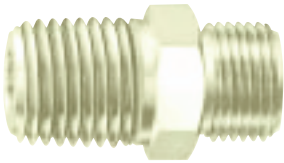

Hose Size	Hose I.D.	Catalog Number	NPT Thread Size	Female Ball Thread
-4	3/16	B-1005/4-1	1/8-27	1/2-24
-4	3/16	B-1005/4-2	1/4-18	1/2-24

Brass Compression Cissel Union Adapter

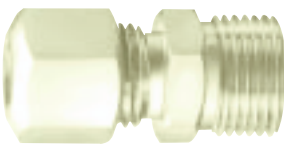

Hose Size	Hose I.D.	Catalog Number	Compression Thread Size	Female Ball Thread
-4	3/16	B-1005/4-CU	5/16-1/4	1/2-24

⚠ WARNING: These hoses can be used to convey hazardous chemicals, steam, hot liquids or other dangerous materials which can cause death, serious bodily injury including burns, pressure wounds or chemical exposure if released accidentally. They should, therefore, only be handled or worked on by personnel properly trained in the safe handling of the materials or chemicals conveyed in the hoses.

⚠ WARNING: Selection of the proper end fitting for the hose end application is essential to the proper operation and safe use of the hose and related equipment. Inadequate attention to the selection of the end fittings for your application can result in leaking or the hose end blowing off the hose, leading to serious personal injury, death or property damage.

Dacron® is a registered trademark of DuPont.
 Teflon® is a registered trademark of DuPont

How to Order 'E' Series Hose Assemblies

Part Numbers for hose assemblies are basically the same as hose ends, except both the ends must be specified as well as the overall length. This process is detailed below.

1. Hose size (I.D.) in sixteenths of an inch (04= 4/16" = 1/4" = S-5TW)
2. 'E' designates crimp ends.
3. Style and material of each hose end. 'C' designates carbon steel end.
Example: 104 Male Pipe 1/4". 604 JIC Female swivel 1/4".
4. Length of assembly. Inches: 1/1000 in.
(29.375 = 29-3/8" assembly length)

NOTE: to determine the hose only length when making a hose assembly subtract each hose end cut-off factor from the overall assembly length. Please see the individual hose end listings for cut-off factor information.



04	E	104C	604C	- 29.375
1	2	3	3	4

ASSEMBLY LENGTH TOLERANCES:

Assemblies up to 18" ± 1/8"

Assemblies 18" - 36" ± 1/4"

Assemblies 36" - 50" ± 1/2"

Assemblies 50" and up ± 1%
of total length

⚠ WARNING: These hoses can be used to convey hazardous chemicals, steam, hot liquids or other dangerous materials which can cause death, serious bodily injury including burns, pressure wounds or chemical exposure if released accidentally. They should, therefore, only be handled or worked on by personnel properly trained in the safe handling of the materials or chemicals conveyed in the hoses.

Tubular Fire Sleeve



Everflex tubular firesleeve has a coating of specially compounded silicone rubber bonded to a low density, high bulk fiberglass sleeve. This combination offers a temporary barrier to flame penetration and provides long term mechanical and environmental protection. Ideal applications include steel plants, foundries, glass plants, and welding/cutting shops.

Operating temperatures: **Tested in accordance with:**
 Continuous: -65° - +500°F UL-73, NFPA-250, ASTM-E84
 Intermittent: -65° to +2000°F

Hose Size	Hose I.D.	Assembly Part Number
-4	3/16	SFS-1/2
-5	1/4	SFS-1/2
-6	5/16	SFS-11/16
-8	13/32	SFS-11/16
-10	1/2	SFS-11/16
-12	5/8	SFS-15/16
-16	7/8	SFS-1 1/4
-16Z†	7/8	SFS-1 1/4
-20Z†	1-1/8	SFS-1 1/2

Heat Shrinkable Chafe Sleeve



Everflex heat shrink chafe sleeve is made of black flame retardant polyolefin. In addition to providing excellent chafe resistance, the sleeve can also be wiped clean. This problem solver is ideal for any application where the assembly is subjected to abuse through abrasion.

Operating temperatures: -65° - +275°F

Hose Size	Hose I.D.	Assembly Part Number
-4	3/16	HSP-1/2
-5	1/4	HSP-1/2
-6	5/16	HSP-3/4
-8	13/32	HSP-5/8
-10	1/2	HSP-1
-12	5/8	HSP-1
-16	7/8	HSP-1 1/2
-16Z†	7/8	HSP-1 1/2
-20Z†	1-1/8	HSP-1 1/2

Spring Guard

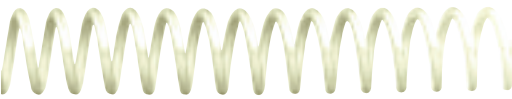

Everflex spring guard is available in hot dipped galvanized carbon steel. This method of protection is well suited for applications where rough handling, abrasion and severe flexing will occur.

Hose Size	Hose I.D.	Assembly Part Number
-4	3/16	2004
-5	1/4	2005
-6	5/16	2006
-8	13/32	2008
-10	1/2	2010
-12	5/8	2012
-16	7/8	2016
-16Z†	7/8	2016Z
-20Z†	1-1/8	2020Z

Tight Pitch Spring Guard

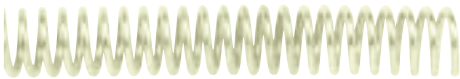

Everflex spring guard is available in hot dipped galvanized carbon steel. This method of protection is well suited for applications where rough handling, abrasion and severe flexing will occur. Tight pitch spring guard is widely accepted in maintenance applications on rubber tire manufacturing presses.

Hose Size	Hose I.D.	Assembly Part Number
-4	3/16	2004T
-5	1/4	2005T
-6	5/16	2006T
-8	13/32	2008T
-10	1/2	2010T
-12	5/8	2012T
-16	7/8	2016T
-16Z†	7/8	2016ZT
-20Z†	1-1/8	2020ZT

302 Stainless Steel Internal Spring Guard



Everflex internal spring guard is available in 302 stainless steel. Spring guards prevent kinking and protect the hose from abrasion and rough handling.

Hose Size	Hose I.D.	Assembly Part Number
-5	1/4	2005I
-8	13/32	2008I
-16	3/8	2016I
-20Z†	1-1/8	2020ZI

† The 16Z, and 20Z sizes have a double stainless steel wire reinforcement.

Conv-O-Crimp™ Convoluted

Hose

Everflex Conv-O-Crimp 8000 Series hose provides excellent performance, reliability and durability under a wide range of environmental, pressure, temperature and chemical conditions. When compared with large diameter rubber hose, Conv-O-Crimp is dramatically lighter weight, more flexible, and more resistant to heat and chemicals. The tube is fabricated with tape of teflon and reinforced with 304 stainless steel wire. The result is a product ideally suited for applications in truck and bus, chemical processing, food processing, hydraulics, pharmaceutical, tire manufacturing, steel mills, and many others. In addition to the standard 8000 Series virgin white tube of Teflon, the 8500 Series has an internal conductive static dissipating black liner provides a path to the hose end fitting for applications where flow induced electrostatic charges can occur.



Construction:

Convoluted Teflon tube with 304 stainless steel wire braid reinforcement.

Operating Temperature Range: -65° to + 400° F
(-54°C to + 204°C)

Industrial applications include:

- Automotive
- Bus & Truck
- Chemical Processing
- Electronics
- Food Processing
- Platten Presses
- Reverse Osmosis
- Steam, Air, Water
- Steel Mills
- Tank Truck Transfer
- Pharmaceutical
- Hydraulics
- Tire Manufacturing

Non-Conductive	Hose Size	Hose I.D.	Non-Conductive Catalog Number	Nominal I.D. (in.)	Nominal O.D. (in.)	Max. Operating Pressure (psi)	Burst Pressure (psi) Rm. Temp.	Min. Bend Rad. (in.)	Vacuum (in./Hg)	Hose Weight (lb./ft.)
	-8	1/2	8008	.53	.78	1550	6200	1.5	28	.23
-12	3/4	8012	.78	1.05	1250	5000	2.5	28	.31	
-16	1	8016	1.03	61.32	1000	4000	3.0	20	.42	
-20	1-1/4	8020	1.28	1.58	1000	4000	3.5	12	.52	
-24	1-1/2	8024	1.53	1.83	750	3000	4.5	10	.59	
-32	2	8032	2.03	2.38	550	2200	6.0	5	.86	

Conductive	Hose Size	Hose I.D.	Conductive Catalog Number	Nominal I.D. (in.)	Nominal O.D. (in.)	Max. Operating Pressure (psi)	Burst Pressure (psi) Rm. Temp.	Min. Bend Rad. (in.)	Vacuum (in./Hg)	Hose Weight (lb./ft.)
	-8	1/2	8508	.53	.78	1550	6200	1.5	28	.23
-12	3/4	8512	.78	1.05	1250	5000	2.5	28	.31	
-16	1	8516	1.03	1.32	1000	4000	3.0	20	.42	
-20	1-1/4	8520	1.28	1.58	1000	4000	3.5	12	.52	
-24	1-1/2	8524	1.53	1.83	750	3000	4.5	10	.59	
-32	2	8532	2.03	2.38	550	2200	6.0	5	.86	

⚠ WARNING: These hoses can be used to convey hazardous chemicals, steam, hot liquids or other dangerous materials which can cause death, serious bodily injury including burns, pressure wounds or chemical exposure if released accidentally. They should, therefore, only be handled or worked on by personnel properly trained in the safe handling of the materials or chemicals conveyed in the hoses.

CONVOLUTED HOSE

Everflex Conv-O-Crimp hose end design is so unique, it is protected under U.S. Patent No. 5,209,267. In addition to the unique configuration of the hose end, Everflex ships every Conv-O-Crimp fitting with a factory installed sleeve on the insert. This eliminates the time consuming, costly and subjective step of wrapping the hose end with Teflon tape before assembly. The end result is a hose assembly system that is second to none in ease of assembly fabrication. Common industrial configurations are available in carbon steel and 316 stainless steel(wetted surfaces), while flange retainers are available in 316 stainless steel encapsulated in PFA Teflon or 316 stainless steel (wetted surfaces). Finished assemblies can be acquired from an authorized Everflex distributor or the Everflex factory.

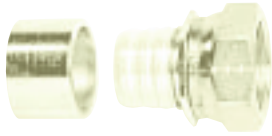

Material Code:

A= 316S.S., Nut & Collar - 304 S.S.
 B= Insert - 316 S.S., Nut - 304 S.S., Collar - Carbon Steel Plated
 C= All Components - Carbon Steel Plated

Male Pipe		Hose Size	Hose I.D.	Catalog No.	Part No. Suffix Letter	Thread NPT	A Overall Length In.	Hose Cut-off Factor†	Nominal I.D. In.
		-8	1/2	8-108	A,B,C	1/2-14	2.33	1.56	.406
		-12	3/4	12-112	A,B,C	3/4-14	2.48	1.56	.625
		-16	1	16-116	A,B,C	1 11-1/2	2.95	1.93	.828
		-20	1-1/4	20-120	A,B,C	1 1/4-11-1/2	2.98	1.93	1.078
		-24	1-1/2	24-124	A,B,C	1 1/2-11-1/2	3.01	1.93	1.305
		-32	2	32-132	A,B,C	2 11-1/2	3.43	2.12	1.781

JIC 37° Swivel		Hose Size	Hose I.D.	Catalog No.	Part No. Suffix Letter	Thread NPT	A Overall Length In.	Hose Cut-off Factor†	Nominal I.D. In.
		-8	1/2	8-608	A,B,C	3/4-16	1.82	1.00	.406
		-12	3/4	12-612	A,B,C	1 1/6-12	2.01	1.06	.625
		-16	1	16-616	A,B,C	1 5/16-12	2.14	1.06	.828
		-20	1-1/4	20-620	A,B,C	1 5/8-12	2.20	1.12	1.078
		-24	1-1/2	24-624	A,B,C	1 7/8-12	2.27	1.25	1.305
		-32	2	32-632	A,B,C	2 1/2-12	2.62	1.31	1.781

Flange Retainer		Hose Size	Hose I.D.	Catalog No.	Part No. Suffix Letter	A Overall Length In.	Hose Cut-off Factor†	Nominal I.D. In.
		-8	1/2	8-F00	A,B	2.13	1.31	.406
		-12	3/4	12-F00	A,B	2.43	1.43	.625
		-16	1	16-F00	A,B	2.58	1.50	.828
		-20	1-1/4	20-F00	A,B	2.60	1.56	1.078
		-24	1-1/2	24-F00	A,B	2.72	1.62	1.305
		-32	2	32-F00	A,B	3.11	1.81	1.781

Flange ordered separately see chart below.

Flange Retainer - PFA Encapsulated		Hose Size	Hose I.D.	Catalog No.	Part No. Suffix Letter	A Overall Length In.	Hose Cut-off Factor†	Nominal I.D. In.
		-12	3/4	12-E00	A,B	2.675	1.567	.500
		-16	1	16-E00	A,B	2.892	1.626	.668
		-20	1-1/4	20-E00	A,B	2.892	1.625	.910
		-24	1-1/2	24-E00	A,B	3.030	1.745	1.135
		-32	2	32-E00	A,B	3.470	1.935	1.610

Flange ordered separately see next pg.

⚠ WARNING: Selection of the proper end fitting for the hose end application is essential to the proper operation and safe use of the hose and related equipment. Inadequate attention to the selection of the end fittings for your application can result in leaking or the hose end blowing off the hose, leading to serious personal injury, death or property damage.

†To determine the correct length of hose, subtract the cut-off factor for each end fitting from the overall length of assembly.

Sanitary Tri-Clamp

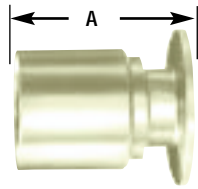

Hose Size	Hose I.D.	Catalog No.	Part No. Suffix	A Overall Length In.	Hose Cut-off Factor†	Nominal I.D. In.
-16	1	16-S16	A	2.14	1.06	.828
-24	1-1/2	24-S24	A	2.14	1.06	1.305
-32	2	32-S32	A	2.40	1.06	1.781

150 LB. ANSI Flange

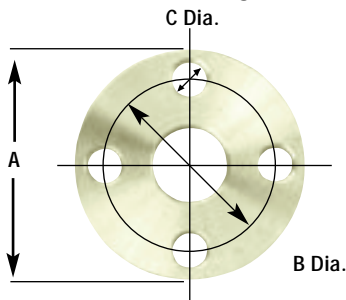

Hose Size	Hose I.D.	Catalog No.	Part No. Suffix	Number Bolt Holes	A	B	C
-8	1/2	CF15-8	CS,304,316	4	3.50	2.38	.62
-12	3/4	CF15-12	CS,304,316	4	3.88	2.75	.62
-16	1	CF15-16	CS,304,316	4	4.25	3.12	.62
-20	1-1/4	CF15-20	CS,304,316	4	4.63	3.50	.62
-24	1-1/2	CF15-24	CS,304,316	4	5.00	3.88	.62
-32	2	CF15-32	CS,304,316	4	6.00	4.75	.75

300 LB. ANSI Flange

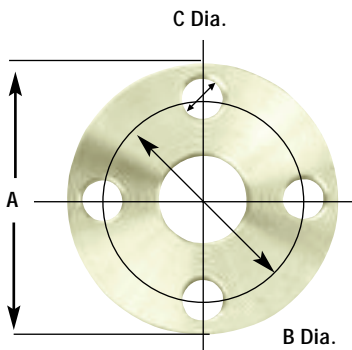

Hose Size	Hose I.D.	Catalog No.	Part No. Suffix	Number Bolt Holes	A	B	C
-8	1/2	CF 30-08-CS	CS,304,316	4	3.50	2.38	.62
-12	3/4	CF 30-12-CS	CS,304,316	4	3.88	2.75	.62
-16	1	CF 30-16-CS	CS,304,316	4	4.25	3.12	.62
-20	1-1/4	CF 30-20-CS	CS,304,316	4	4.63	3.50	.62
-24	1-1/2	CF 30-24-CS	CS,304,316	4	5.00	3.88	.62
-32	2	CF 30-32-CS	CS,304,316	4	6.00	4.75	.75

Material Code:

A= 316SS., Nut & Collar - 304 S.S.
 CS=Carbon Steel
 304=304 Stainless Steel
 316=316 Stainless Steel

⚠ WARNING: Selection of the proper end fitting for the hose end application is essential to the proper operation and safe use of the hose and related equipment. Inadequate attention to the selection of the end fittings for your application can result in leaking or the hose end blowing off the hose, leading to serious personal injury, death or property damage.

† To determine the correct length of hose, subtract the cut-off factor for each end fitting from the overall length of assembly.

How To Order Conv-O-Crimp™

How to Order Conv-O-Crimp Bulk Hose & Fittings:

HOSE:

Specify quantity and part number.

Example:

500' 8008 100' 8532

FITTINGS:

Specify quantity and part number.

Example:

100 pcs. 8-108-A 50 pcs. 32-632-B

How to Order Conv-O-Crimp Hose Assemblies:

Hose Assembly Part Number					Flange Type			
XXXX	XXX X	XXX X	XXX	-	XXXX.XXX	Code	Class	Material
Hose Type & Size	Fitting Style* & Material(s)	Fitting Style* & Material(s)	Special Features		Assembly Length			
See Page 30	See Page 31 & 32	See Page 31 & 32	Consult Factory		Inches: 1/1000 in.	11	150 lb.	Carbon Steel
						14	150 lb.	304 Stainless Steel
						16	150 lb.	316 Stainless Steel
						31	300 lb.	Carbon Steel
						34	300 lb.	304 Stainless Steel
						36	300 lb.	316 Stainless Steel
						XX		Special or Customer Supplied

* Flange retainer fittings must include a flange type code as part of the fitting style number (see flange type chart and example B.)

Example A:

Hose Assembly Requirements:

- 1/2" I.D. non-conductive convoluted hose
- 1/2" N.P.T. male pipe fitting, all stainless steel - one end
- JIC 37° swivel fitting, all stainless steel - other end
- 29-3/8" assembly length
- No special features

Part Number: 8008108A608A-29.375

Example B:

Hose Assembly Requirements:

- 1" I.D. conductive convoluted hose
- 1" flange retainer fitting, all stainless steel - each end
- 150 lb., 304 stainless steel flange
- 47" assembly length

Part Number: 8516F14AF14A-47.000

Fitting Style ———— Fitting Material
 Flange Class - 150lb. ———— Flange Material - 304 stainless steel

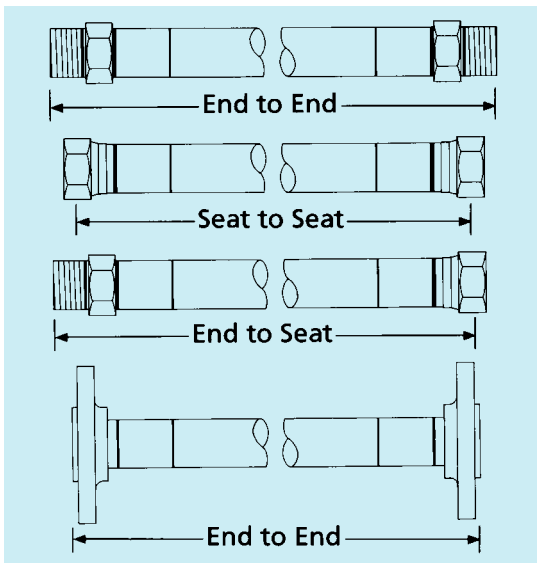

Measurement Information

All assembly length fractional measurements should be expressed in decimals thousandths (e.g. 29 3/8" = 29.375"). The diagram to the left illustrates how to determine assembly length with various end fitting configurations. Hose assembly cut length is established by subtracting the desired fitting "deduct" dimensions from the required length.

Assembly Length Tolerances:

- Assemblies up to 18" ± 1/8"
- Assemblies up to 18" - 36" ± 1/4"
- Assemblies up to 36" - 50" ± 1/2"
- Assemblies 50" and up ± 1% of total length.

T-400-1EF Everswage Press

T-401-EF Fabricating Distributor Kit

Fabricating distributor kit including a press with master pusher, hydraulic pump, hose assembly, swage die holder, pusher adapters, and swage dies for 'S' Series, .040 wall hose -4 to -16.

T-400-71 Conversion Kit for Weatherhead T-400-1 Press

Conversion kit for Weatherhead T-400-1 press including master pusher, swage die holder, and pusher adapters.

T-400-89 Conversion Kit for Weatherhead T-400-1 Press

Conversion kit for Weatherhead T-400-1 press including master pusher, swage die holder, pusher adapter and swage dies for 'S' Series, .040 wall hose -4 to -16.

TE-Kit

Includes all tube expanders for Smooth Bore Hose.



Model #	Description	Model #	Description	.040" Wall	Swage Dies
T-400-1EF	Everswage Press w/ Master Pusher	PT-Pusher	Power Trim Fitting Pusher	SD-3-15°	Swage Die 1/8"
T-400-16	Hose Assembly	T-400-84	Master Pusher	SD-4-15°	Swage Die 3/16"
T-400-72	Pusher Adapter	T-400-85	Swage Die Holder	SD-5-15°	Swage Die 1/4"
T-400-73	Pusher Adapter	T-421U	Hydraulic Pump	SD-6-15°	Swage Die 5/16"
T-400-74	Pusher Adapter	T-400-BB	Convert switch for	SD-8-15°	Swage Die 13/32"
T-400-75	Pusher Adapter		T-421U Pump	SD-10-15°	Swage Die 1/2"
T-400-76	Pusher Adapter	TE-3	Tube Expander for -3	SD-12-15°	Swage Die 5/8"
T-400-77	Pusher Adapter	TE-4	Tube Expander for -4	SD-16-15°	Swage Die 7/8"
T-400-78	Pusher Adapter	TE-5	Tube Expander for -5	SD-20Z-15°	Swage Die 1-1/8"
T-400-79	Pusher Adapter	TE-6	Tube Expander for -6		
T-400-80	Pusher Adapter	TE-8	Tube Expander for -8	.030 Wall	Swage Dies
T-400-81	Pusher Adapter	TE-10	Tube Expander for -10	SD-4-TW-15°	Swage Die 3/16" TW
T-400-82	Pusher Adapter	TE-12	Tube Expander for -12	SD-5-TW-15°	Swage Die 1/4" TW
		TE-16	Tube Expander for -16	SD-6-TW-15°	Swage Die 5/16" TW
		TE-20	Tube Expander for -20	SD-8-TW-15°	Swage Die 13/32" TW
				SD-10-TW-15°	Swage Die 1/2" TW
				SD-12-TW-15°	Swage Die 5/8" TW
				SD-16-TW-15°	Swage Die 7/8" TW
				EFH-135X	50 Drawer Cabinet
				EFS-100	Blank Labels for EFH-135X
				T-400-ED	Pusher Selector Decal

⚠ WARNING: You must hold the hose assembly in place from below throughout the swage or crimping operation. Do not place fingers or hands at the swage or crimping point during operation. Failure to follow this procedure could result in serious injury to your hand or finger. The use or intermixing of fittings and hose not specifically engineered and designed for use with the Everflex equipment may result in the production of an unsafe or unreliable hose assembly. The Everflex limited warranty is contingent upon the fact that only Everflex end fittings and Everflex hose be used on Everflex assembly equipment.

T-421U Electric Pump

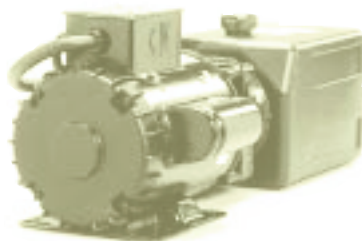

Dimensions 7 1/2" high, 10" wide, 22" long
 Weight66 lbs.
 Reservoir Size 1.45 cu. in.
 Outlet Port Size 3/8" NPT or 3/4"-16 Straight Thread
 Motor 1 H.P., 3450 RPM, 115/220 Volts, 60 Cycles, Single Phase
 Hydraulic Oil Gulf Harmony 100 AW Gulf Harmony 64 or 68, SAE 10 Grade,
 SAE 20 Grade, Sunvis 931, Mobil DTE 26 Or, Mobil DTE 24 (30° F Below)
 Reservoir Capacity 3 Quarts
 Flow0.5 GPM

Everswage™ Tooling Selector Chart

Hose Size	Hose End	S Series Swage Die	STW Series Swage Die	Pusher Adaptor	S Swage DIA	STW Swage DIA
-3	1103	SD-3-15	NA	T-400-73	.308	.367
-4	1104-1	SD-4-15	SD-4TW-15	T-400-73	.382	.367
-4	1104-2	SD-4-15	SD-4TW-15	T-400-72	.382	.453
-5	1105	SD-5-15	SD-5TW-15	T-400-72	.468	.453
-5	1105-1/8	SD-5-15	SD-5TW-15	T-400-73	.468	.453
-6	1106-1	SD-6-15	SD-6TW-15	T-400-71	.533	.518
-6	1106-2	SD-6-15	SD-6TW-15	T-400-80	.533	.518
-6	1106-3	SD-6-15	SD-6TW-15	T-400-78	.533	.518
-8	1108-1	SD-8-15	SD-8TW-15	T-400-79	.632	.614
-8	1108-2	SD-8-15	SD-8TW-15	T-400-78	.632	.614
-10	1110	SD-10-15	SD-10TW-15	T-400-77	.739	.724
-12	1112	SD-12-15	SD-12TW-15	T-400-76	.883	.875
-16	1116	SD-16-15	SD-16TW-15	T-400-74	1.194	1.179
-16Z	1116Z	SD-16-15	NA	T-400-74	1.194	NA
-20Z	1120Z	SD-20Z-15	NA	Not Needed	1.423	NA
-3	1303	SD-3-15	NA	T-400-81	.308	NA
-3	1303-4	SD-3-15	NA	T-400-81	.308	NA
-4	1304	SD-4-15	SD-4TW-15	T-400-81	.382	.367
-5	1305	SD-5-15	SD-5TW-15	T-400-72	.468	.453
-6	1306	SD-6-15	SD-6TW-15	T-400-72	.533	.518
-8	1308	SD-8-15	SD-8TW-15	T-400-78	.632	.614
-10	1310	SD-10-15	SD-10TW-15	T-400-76	.739	.724
-12	1312	SD-12-15	SD-12TW-15	T-400-76	.883	.875
-16	1316	SD-16-15	SD-16TW-15	T-400-75	1.194	1.179
-16Z	1316Z	SD-16-15	NA	T-400-75	1.194	NA
-20Z	1320Z	SD-20Z-15	NA	T-400-74	1.423	NA
-4	#30	SD-4-15	SD-4TW-15	T-400-81	.382	.367
-5	#31	SD-5-15	SD-5TW-15	T-400-72	.468	.453
-6	#32	SD-6-15	SD-6TW-15	T-400-72	.533	.518
-8	#33	SD-8-15	SD-8TW-15	T-400-78	.632	.614
-10	#34	SD-10-15	SD-10TW-15	T-400-76	.739	.724
-12	#35	SD-12-15	SD-12TW-15	T-400-76	.883	.875
-4	2104-1	SD-4-15	SD-4TW-15	T-400-82	.382	.367
-4	2104-2	SD-4-15	SD-4TW-15	T-400-81	.382	.367
-5	2105	SD-5-15	SD-5TW-15	T-400-81	.468	.453
-4	STE4-4	SD-4-15	SD-4TW-15	TE4-4 With T-400-75	.382	.367
-5	STE4-5	SD-5-15	SD-5TW-15	TE4-5 With T-400-75	.468	.453
-6	STE6-6	SD-6-15	SD-6TW-15	TE6-6 With T-400-75	.533	.518
-8	STE8-8	SD-8-15	SD-8TW-15	TE8-8 With T-400-75	.632	.614
-12	STE12-12	SD-12-15	SD-12TW-15	TE12-12 With T-400-75	.883	.875
-16	STE16-16	SD-16-15	SD-16TW-15	TE16-16 With T-400-75	1.194	1.179
-6	B-6LFC	SD-6-15	SD-6TW-15	T-400-73	.533	.518
-12	#60	SD-12-15	SD-12TW-15	Consult Factory	.883	.875
-16	#61	SD-16-15	SD-16TW-15	Consult Factory	1.194	1.179
-16	#62	SD-16-15	SD-16TW-15	Consult Factory	1.194	1.179
-5	C-5PS	SD-5-15	SD-5TW-15	T-400-81	.468	.453
-4	PT-S-4	SD-4-15	SD-4TW-15	PT-Pusher	.382	.367
-4	PT-45-4	SD-4-15	SD-4TW-15	PT-Pusher	.382	.367
-4	PT-90-4	SD-4-15	SD-4TW-15	PT-Pusher	.382	.367
-10	10-S.37-316	SD-10-15	SD-10TW-15	T-400-82	.739	.724
-16	16-S.87-316	SD-16-15	SD-16TW-15	T-400-82	1.194	1.179
-10	#40	SD-10-15	Sd-10TW-15	40 With T-40-75	.739	.724
-10	#41	SD-10-15	SD-10TW-15	TE10-10 With T-400-75	.739	.724

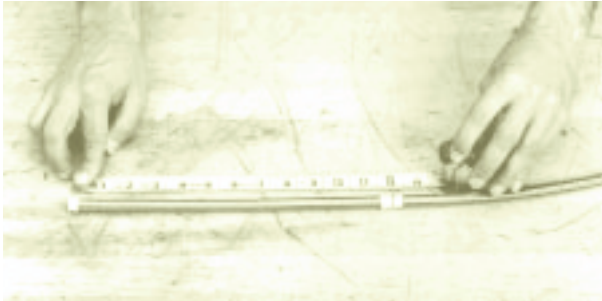
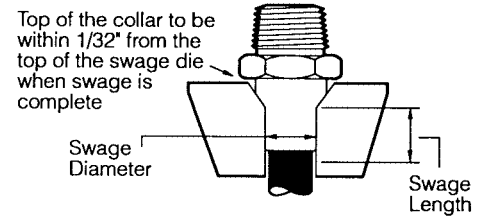
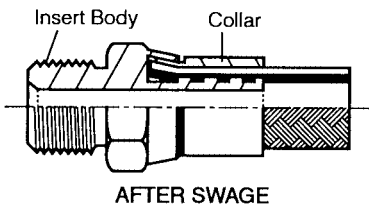
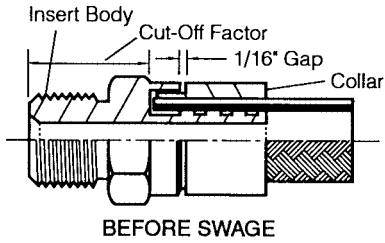

1) Measure hose to desired cut-off length. Wrap cut-off point with masking tape and mark. Desired length is determined by subtracting deduct factor of both hose ends from overall length of hose assembly.

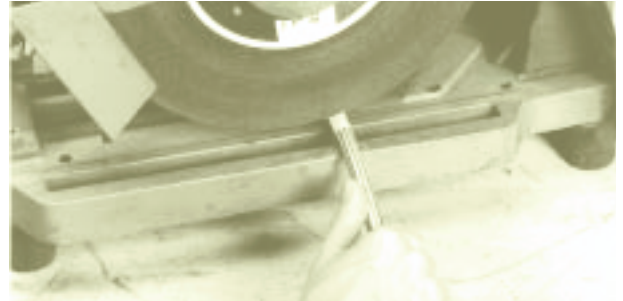

2) Cut hose squarely with cut-off saw as shown. (Abrasive and steel wheels perform well.)



3) Slide collars over hose where braid is more tapered to the tube for easier collar placement. Remove masking tape and make sure collar has proper orientation.



4) Expand the inner Teflon tube for hose end insertion. Use the proper TE expander per size (page 34) with rotational speed not to exceed 200 rpm.



5) Holding collar flush with the cut end, push the hose and collar over the stem of the fitting insert until the collar bottoms in the trepan cavity. (Exceptions; Sizes -3, -4. Push hose and collar to the entrance of the short collar, then slide the collar forward over the hose until it is seated in the trepan cavity.)



6) Insert correct pusher adapter into the master pusher. Refer to selector chart T-400-ED on the front of press. (See chart on page 35)



7) Place correct swage die halves into swage die holder T-400-85. Refer to selector chart T-400-ED. (See chart on page 35)



8) Lubricate collar with dry PTFE lubricant prior to swaging.



9) Place hose assembly in swage dies so bottom of collar rests in chamfered opening of dies.

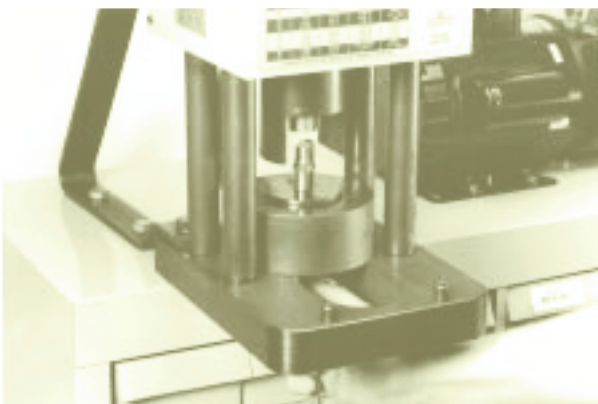

10) Slide swage die holder back against the rear locating stops.

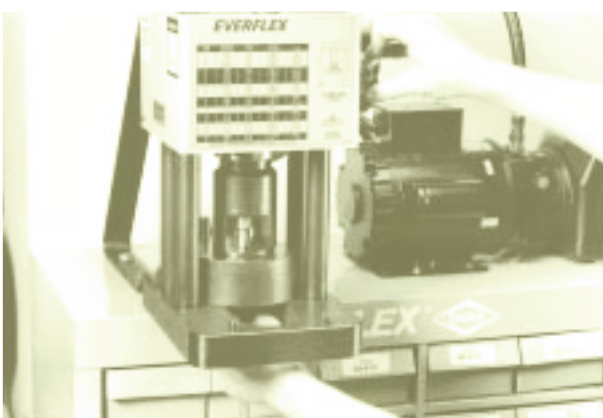

11) Hold hose assembly from underneath press and activate pump to swage hose end to hose. When pusher bottoms out on split die, swaging is complete. Release electric switch to retract pusher. Slide swage die holder forward.



12) Remove swaged hose assembly and visually inspect the swaged end. To ensure a proper swage has been completed, measure the nominal crimp diameter as shown on page 35.

Nominal Crimp Diameter Measurement

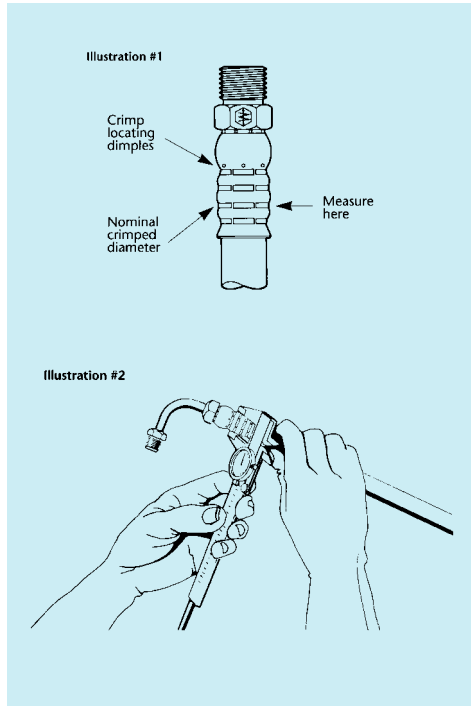

Measuring crimp diameters should be a part of the nominal hose assembly procedure. To insure a proper crimp diameter reading, follow these steps.

1. Measure the diameter in the middle of the crimped portion of the hose end. (see illustration #1)
2. Place the caliper in a position to allow a measurement in the horizontal depressions of the crimp spaced 180° apart. (see illustration #1 & #2)
3. See crimp diameters on the following chart.

Note: In the larger sizes, calipers may be used; however in the smaller sizes, a point micrometer will provide an accurate reading.

'E' Series Tooling (For crimping 'E' series hose ends using the Everswage™ Press)

Model #	Description	Hose Dash Size	Hose I.D.	Hose End Prefix	Collet	Spacer Ring		Nominal Crimp Dia.
						Color	Flat Size	
T-400-30C	Kit includes 1 each of all collets							
FS-1200	Label set/Layout Guide	S-4TW	3/16	03E	T-400-113C	Tan	Up	.355
T-400-8	Die Ring	S-5TW	1/4	04E	T-400-31C	Green	Up	.405
T-432-15	Master Pusher	S-6TW	5/16	05E	T-400-32C	Red	Up	.475
T-400-37	Green Spacer Ring	S-7TW	3/8	06E	T-400-33C	Red	Up	.545
T-400-38	Red Spacer Ring	S-10TW	1/2	08E	T-400-34C	Red	Up	.695
T-400-112	Tan Spacer Ring	S-14TW	3/4	12E	T-400-35C	Red	Up	.978
		S-18ZTW	1	16E	T-400-36C	Red	Up	1.225

NOTE:

Spacer Rings not included in T-400-30C Kit.

'E' Series Assembly Procedures

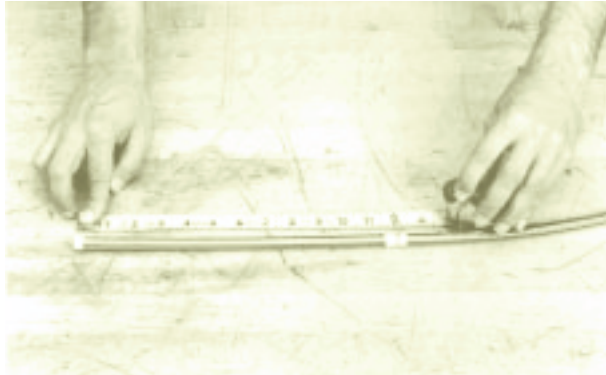

1) Measure Hose to desired length. Wrap cut-off point with masking tape and mark. Desired length is determined by subtracting deduct factor of both ends from overall length of hose assembly.

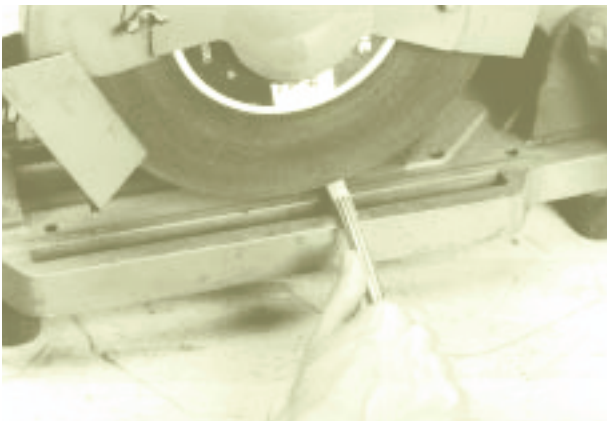

2) Cut hose squarely with cut-off saw as shown. (Abrasive and steel wheels perform well.)

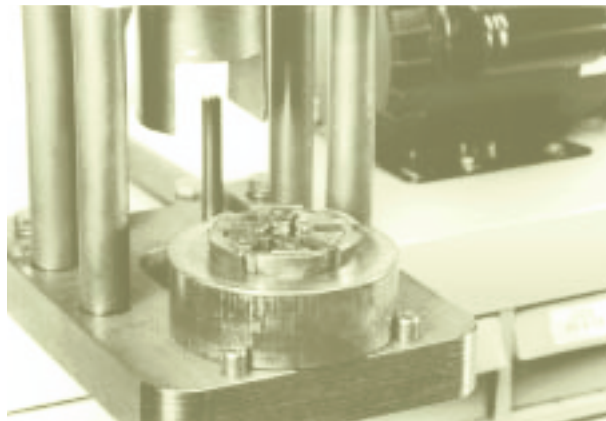

3) Place crimp die ring T-400-8 on base plate against the front stops. Insert correct collet halves in die ring. (See chart on page 38)



4) Place proper size 'E' series hose end on hose. Be sure hose is bottomed in hose end.

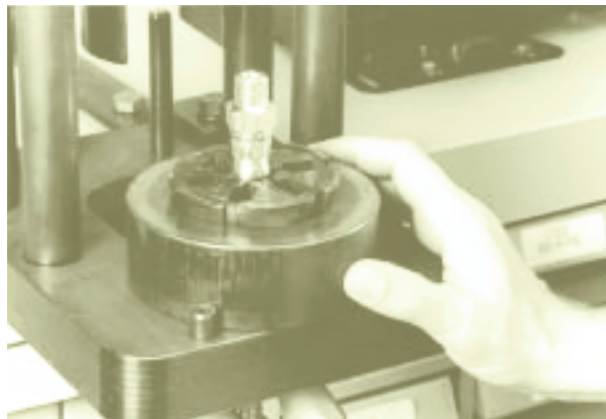

5) Insert hose assembly from below collet halves. Align the dimples on the hose end collar with top of the collet.

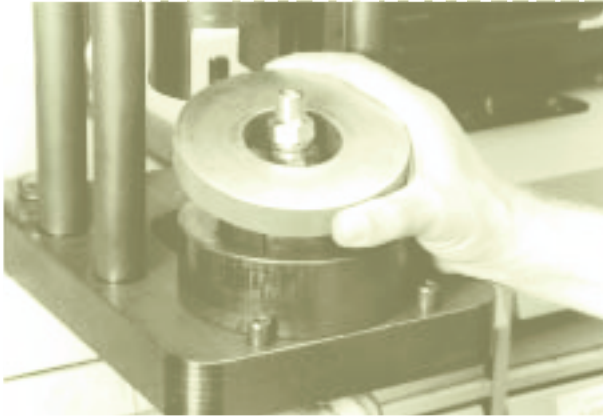

6) Place appropriate side of correct spacer ring on top of collet with uncrimped hose assembly held in place. (See page 38)

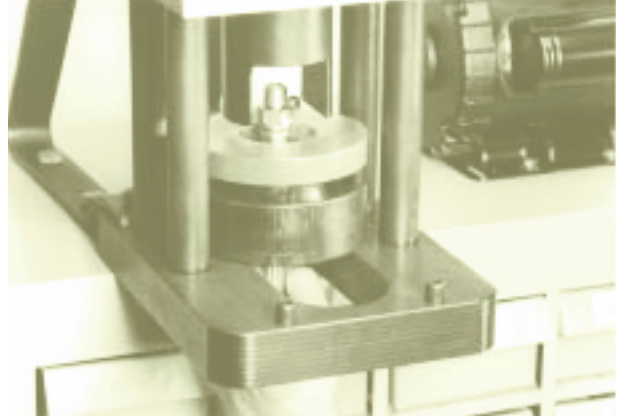

7) Slide crimp die ring back against the rear locating stops.



8) Hold hose assembly from underneath press and activate pump to crimp hose end to hose. When spacer ring contacts die ring, crimping is complete. Release the electric switch to retract pusher. Slide crimp die ring forward.

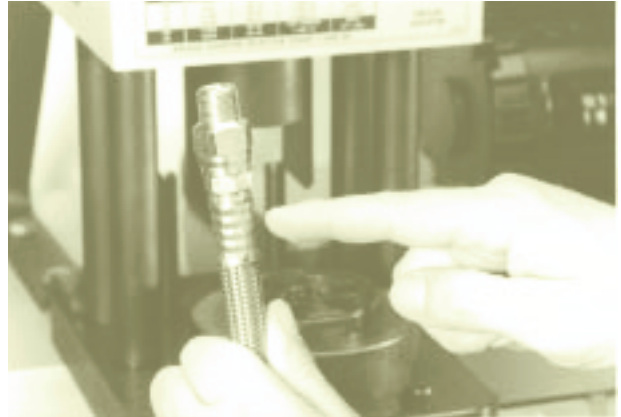

9) Remove crimped hose assembly and visually inspect the crimped end. The crimp on the collar should be located $\pm 1/16$ " from the dimples. To insure a proper crimp has been completed, measure the nominal crimp diameter as shown on page 38.

T-440-1EF Conv-O-Crimp Press

Conv-O-Crimp tooling equipment allows you to make custom factory quality hose assemblies quickly, conveniently and economically. The T-440-1EF press offers the crimping capabilities of 1/2" through 2" I.D. convoluted Teflon hose.

Weight: 450 lbs. Size: 27" High, 21" Deep

T-440-1EFKIT :

Kit includes a press, hydraulic pump, hose assembly, and foot switch kit.

T-890021 Conversion Kit for Weatherhead T-410-1 Press

Kit includes new pusher halves and crimp locator

Model #	Description
T-440-1EF	Press
T-410-22	Hose Assembly
T-441	Electric Pump (two stage)
T-8000	Crimp Collet Kit (all 6 sizes)
T-8008	Collet - 1/2" I.D.
T-8012	Collet - 3/4" I.D.
T-8016	Collet - 1" I.D.
T-8020	Collet - 1 1/4" I.D.
T-8024	Collet - 1 1/2" I.D.
T-8032	Collet - 2" I.D.
T-890024	Tube Expander Kit (all six sizes)
T-890024-8	Tube Expander for -8 hose
T-890024-12	Tube Expander for -8 hose
T-890024-16	Tube Expander for -8 hose
T-890024-20	Tube Expander for -8 hose
T-890024-24	Tube Expander for -8 hose
T-890024-32	Tube Expander for -8 hose
T-890025	Flange Support Kit
T-890026	Foot Switch Kit
T-410-BB	Convert Switch for T-441 Pump

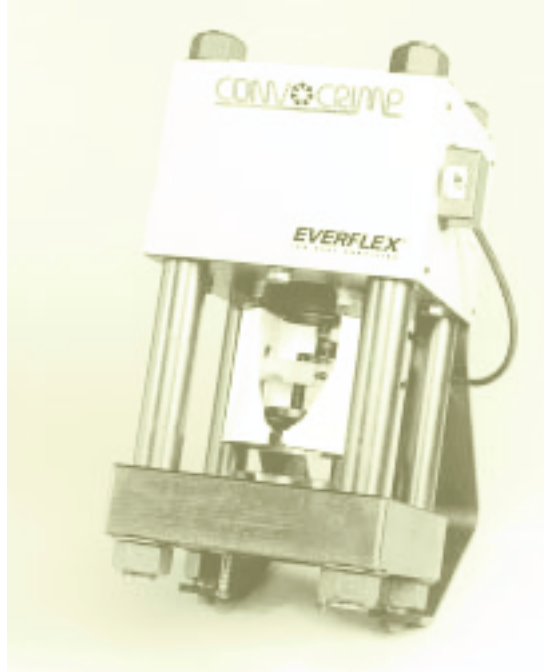

! WARNING: You must hold the hose assembly in place from below throughout the crimping operation. Do not place fingers or hands at the crimping point during operation. Failure to follow this procedure could result in serious injury to your hand or finger.

The use or intermixing of fittings and hose not specifically engineered and designed for use with the Everflex equipment may result in the production of an unsafe or unreliable hose assembly. The Everflex limited warranty is contingent upon the fact that only Everflex end fittings and Everflex hose be used on Everflex assembly equipment.

T-441 Electric Pump

Dimensions7 1/2" high, 10" wide, 22" long
 Weight75 lbs.
 Pressure5000 psi
 Reservoir Capacity6 quarts Outlet Port
 Size3/4-16 straight thread o-ring
 Motor1 HP, 3450 RPM, 115.220 volts, 60 cycles,
single phase.
 Hydraulic OilAutomatic Transmission fluid (ATF)
 Flow2.5 GPM @ 750 psi 0.5 GPM @ 3500 psi

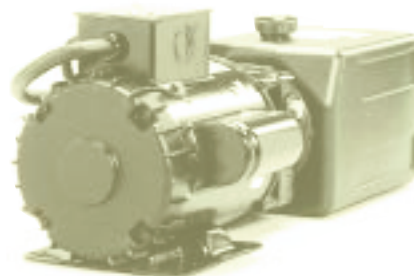

CAUTION: The T-441 electric pump has the relief valve set @ 4000 to 4200 psi. Damage to the press will result and the warranty may be voided if higher pressures are used.

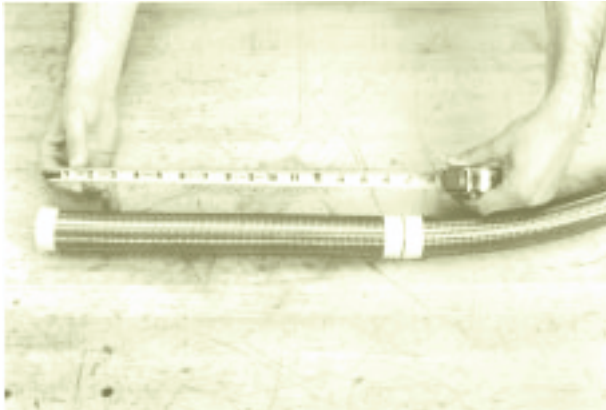

1) Measure hose to desired cut-off length. Wrap cut-off point with masking tape and mark. Desired length is determined by subtracting deduct factor of both hose ends from overall length of hose assembly.



2) Cut hose squarely with cut-off saw as shown. (Abrasive carborundum wheel performs well.)



3) Trim hose and remove debris (wheel grit and pieces of tubing) from cut hose ends.



4) Remove masking tape and install collars on hose end.

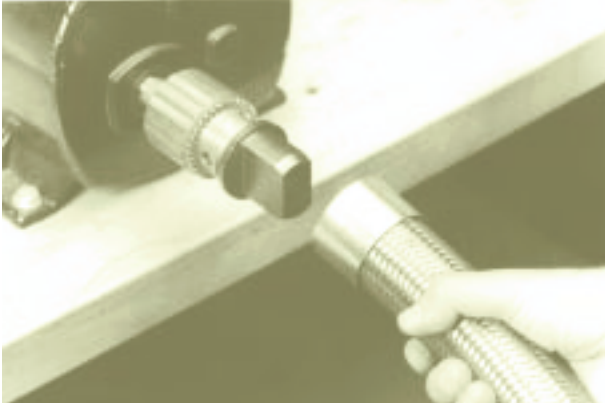

5) Insert the appropriate size tube expander into the end of the hose. Do not exceed 200rpm.



6) Push hose with collar attached onto the desired hose end insert. Hose end should be held in vise as shown.

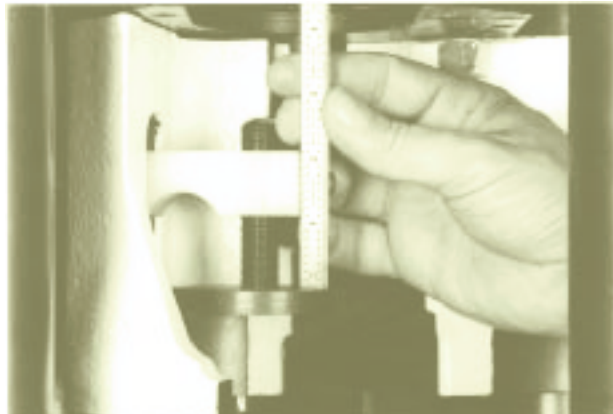

7) After hose end insert is installed, wrap hose with masking tape immediately behind the assembled uncrimped collar. (Tape is used as a gauge to detect movement of the hose prior to or during the crimping operation.)

8) Adjust fitting crimp locator for appropriate hose end fitting configuration. Use table on page 46 and then lock into place.

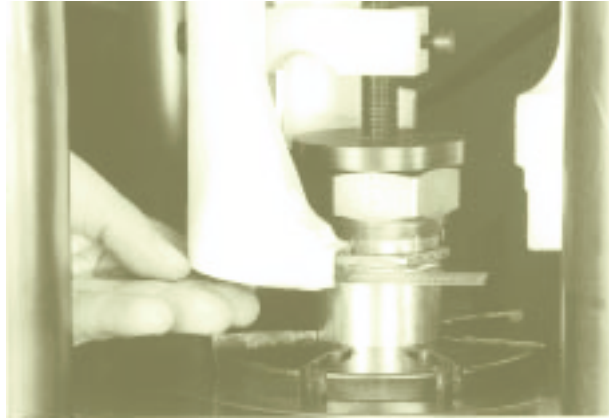

9) Insert hose end through the press base plate and install correct crimp collet halves into press base plate. (See chart on page 41) Check locator dimension with scale to verify pusher bottom is in line with leading edge of the hose end collar.



10) Close both pusher halves. Hold hose assembly from below press and activate pump to crimp hose end to hose. Lift hose end against the fitting locator prior to contact of the pusher with the crimp collet.

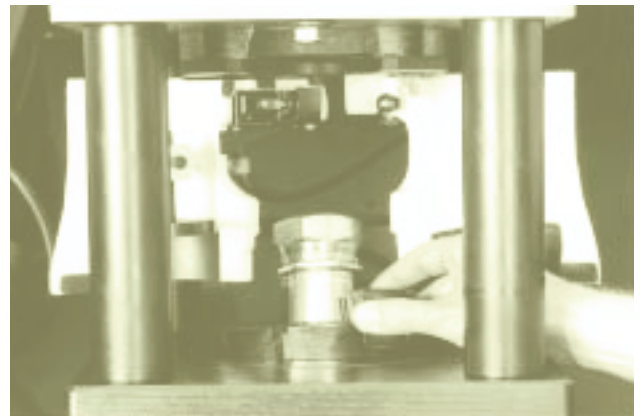
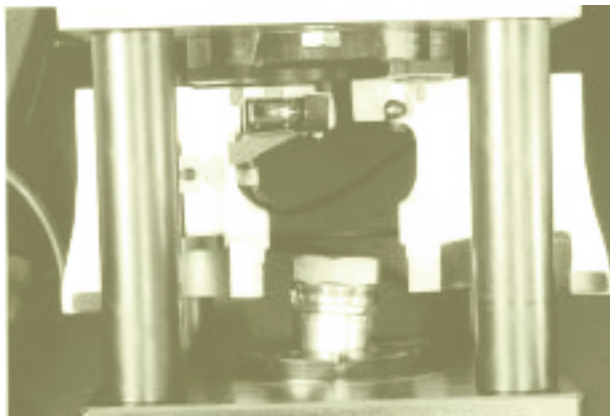

11) Release pressure and allow pusher halves to retract. Remove crimped hose end from press.



12) Visually inspect the crimped end. Check tape below collar to verify hose end did not move during assembly. To insure a proper crimp has been completed, measure the nominal crimp diameter as shown on pages 31–32.

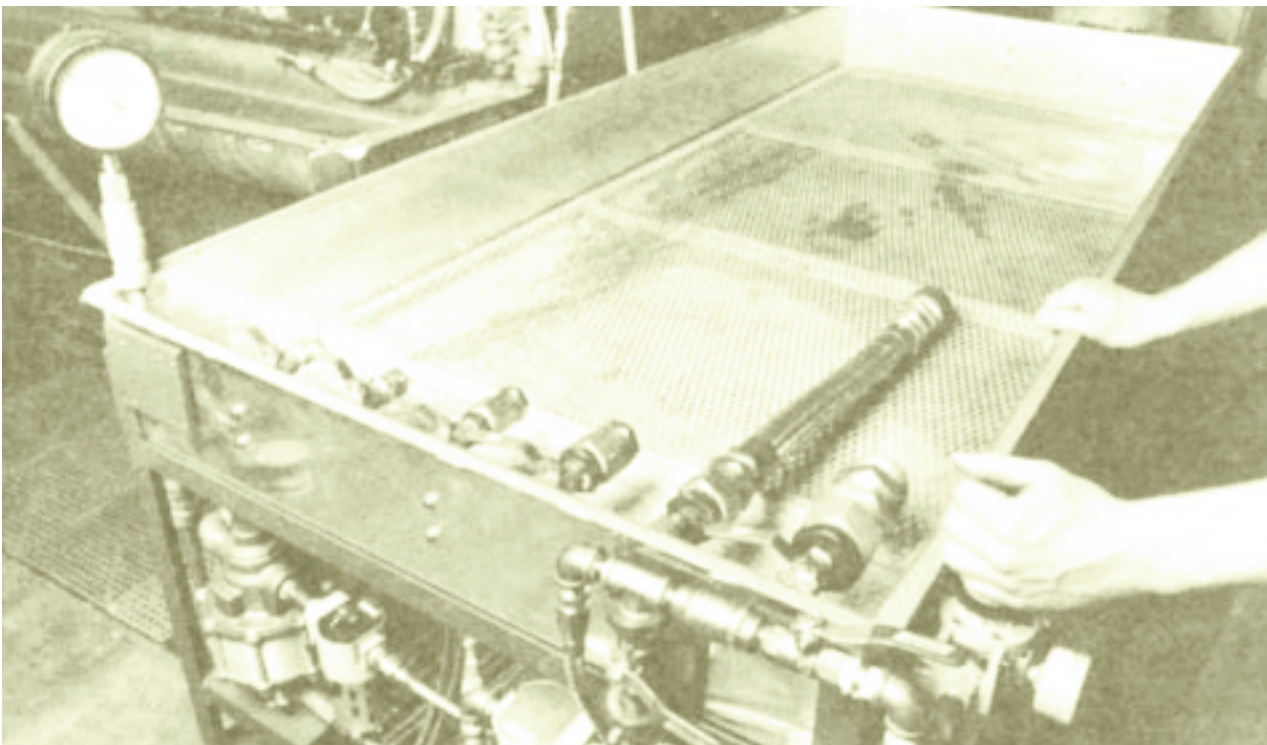

13) Pressure test the completed hose assembly to verify integrity.

Conv-O-Crimp™ Fitting Locator Adjustment

Tooling

INSTRUCTIONS

1. Adjust locator stop to the 'L' dimension for desired fitting configuration. Secure stop with allen screw.
2. With fitting and crimp collet located in base plate, close pusher halves and energize pump.
3. Lift hose and fitting assembly against locator stop just prior to pusher contacting crimp collet.

CAUTION:

- 1) Pusher halves under ram must be closed before pressurizing.
- 2) Maximum operating pressure 5000 p.s.i.

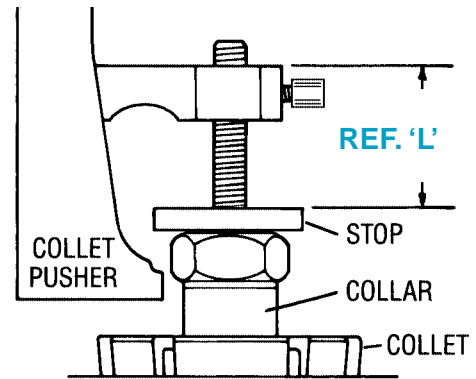

REF. 'L' Dimension Chart

Hose Size	Male NPT	JIC Swivel	Pipe Flange	Sanitary Flange
-8	2-7/16	2-9/16	2-5/8	
-12	2-7/16	2-7/16	2-1/2	
-16	2-1/16	2-3/8	2-7/16	2-7/8
-20	2-1/16	2-5/16	2-3/16	
-24	2	2-1/8	2-3/16	2-7/8
-32	1-13/16	1-3/4	2-3/16	2-7/8

Partial List of Chemicals

This chart has been prepared as a guide only and is NOT a guarantee.

The number of variables present in any particular chemical environment makes firm ratings impossible. Testing under actual service conditions is advisable in all cases to establish suitability of hose for a given purpose.

End fitting material compatibility ratings are based on a fluid temperature of 70° and higher temperatures may accelerate adverse affects.

Where unusual conditions exist, or where questions arise, please consult the factory for assistance. See address on back page.

KEY:

B- Brass
 CS- Carbon Steel
 SS- Stainless Steel
 1- Excellent
 2- Good
 3- Not Recommended
 0- No Information -
 Test Before Using

Media	End Fitting Material					Media	End Fitting Material				
	Teflon	Brass	CS	303/304 S.S.	316SS		Teflon	Brass	CS	303/304 S.S.	316SS
Acetaldehyde	1	1	1	1	1	Barium Hydroxide	1	0	2	1	1
Acetic Acid 10%	1	3	3	2	2	Barium Sulfate	1	2	1	1	1
Acetic Acid 30%	1	3	3	2	2	Barium Sulfide	1	3	3	1	1
Acetic Acid Glacial	1	2	0	2	2	Beer	1	1	2	1	1
Acetic Anhydride	1	3	3	2	2	Beet Sugar Liquids	1	0	1	1	1
Acetone	1	1	1	1	1	Benzene	1	1	1	1	1
Acetylene	1	2	0	1	1	Benzenesulfonic Acid	0	0	3	0	2
Acrylonitrile	1	0	1	1	1	Benzalsdehyde	1	0	1	0	0
Acetyl Chloride	0	0	0	0	0	Benzine	1	1	1	1	1
Alcohols	1	0	3	1	1	Benzyl Alcohol	1	0	1	1	1
Allyl Chloride	0	0	0	0	0	Benzonic Acid	0	0	0	0	0
Alum, Ammonium						Benzoyl Chloride	0	0	0	0	0
Or Potassium	1	3	3	2	2	Benzyl Benzoate	1	0	1	1	1
Aluminum Acetate	1	3	0	1	1	Benzyl Chloride	1	0	1	0	0
Aluminum Bromide	1	3	3	2	2	Bismuth Carbonate	1	0	1	1	1
Aluminum Chloride	1	3	3	2	2	Black Sulphate Liquor	1	0	1	1	1
Aluminum Fluoride	1	3	3	2	2	Blast Furnace Gas	1	1	1	1	1
Aluminum Hydroxide	1	1	0	1	1	Borax	1	1	2	2	1
Aluminum Nitrite	1	0	3	1	1	Bordeaux Mixture	1	0	0	1	1
Aluminum Oxychloride	0	0	0	0	0	Boric Acid	1	3	3	2	1
Aluminum Salts	1	0	0	1	2	Brine	1	2	2	1	1
Aluminium Sulfate	1	3	3	3	2	Bromine Gas	1	3	3	3	3
Ammonia, Anhydrous	1	0	1	1	1	Bromine Liquid	1	3	3	3	3
Ammonia, Aqueous	1	3	0	1	1	Bromine Water	1	3	3	3	3
Ammonium Acetate	0	0	0	0	0	Bunker Oil	1	1	1	1	1
Ammonium Carbonate	0	0	1	1	1	Butadiene	1	1	0	1	1
Ammonium Chloride	1	3	0	2	2	Butane	1	1	1	1	1
Ammonium Fluoride	0	0	0	0	0	Butter Oil	1	1	1	1	1
Ammonium Hydroxide	1	3	2	1	1	Butyric Acid	1	2	3	1	1
Ammonium						Butyl Acetate	1	1	2	1	1
Metaphosphate	1	0	1	1	1	Butyl Alcohol	1	1	1	1	1
Ammonium Nitrate	1	3	1	1	1	Butyl Amine	0	1	1	1	1
Ammonium Nitrite	0	0	0	1	1	Butyl Carbitol	1	1	1	1	1
Ammonium Persulfate	0	0	0	1	1	Butyl Chloride	0	0	0	0	0
Ammonium Phosphate	1	0	3	2	1	Butyl Phenol	0	0	0	0	0
Ammonium Sulfate	1	3	1	1	1	Butyl Stearate	1	1	1	1	1
Ammonium Thiocyanate	1	0	1	1	1	Butyl Mercaptan	1	0	0	1	1
Amyl Acetate	1	1	3	1	1	Butyraldehyde	1	1	0	0	0
Amyl Alcohol	1	1	1	1	1	Cadmium Cyanide	0	0	0	0	0
Amyl Chloride	1	0	0	1	1	Calcium Acetate	1	1	1	1	1
Amyl Chloronaphthalene	1	0	0	1	1	Calcium Bisulfate	1	3	0	2	1
Amyl Naphthalene	1	0	0	1	1	Calcium Carbonate	1	1	1	1	1
Aniline	1	3	2	1	1	Calcium Chlorate	1	0	0	2	1
Aniline Dyes	1	0	3	1	1	Calcium Chloride	1	2	3	2	1
Aniline Hydroxide	1	3	0	3	3	Calcium Hydroxide	1	2	3	3	1
Animal Fats	1	0	1	1	1	Calcium Hypochlorite	1	3	0	3	2
Antimony Chloride	0	0	0	0	0	Calcium Nitrate	1	1	1	1	1
Antimony Trochloride	0	0	0	0	0	Calcium Silicate	1	1	1	1	1
Aqua Regia	1	0	0	3	3	Calcium Sulfate	1	1	1	1	1
Arsenic Acid	1	0	2	0	1	Calcium Sulfide	1	0	1	1	1
Askarel	0	1	1	1	1	Calcium Phosphate	0	0	0	0	0
Asphalt	1	2	1	1	1	Cane Sugar Liquors	1	2	1	1	1
Barium Carbonate	1	1	2	1	1	Caprylic Acid	0	0	0	0	0
Barium Chloride	1	2	3	1	1	Carbonic Acid	1	3	3	1	1

Chemical Resistance Chart

Chart

Media	End Fitting Material					Media	End Fitting Material				
	Teflon	Brass	CS	303/304 S.S.	316SS		Teflon	Brass	CS	303/304 S.S.	316SS
Carbon Dioxide	1	1	1	1	1	Ethylene Chlorohydrin	1	0	0	0	0
Carbon Disulfide	0	2	2	1	1	Ethylene Diamine	1	1	0	0	0
Carbonic Acid	1	3	3	1	1	Ethylene Dichloride	1	1	3	3	3
Carbon Monoxide	1	1	1	1	1	Ethylene Glycol	1	1	2	1	1
Carbon Tetrachloride	1	2	3	2	2	Ethylene Oxide	0	0	0	0	0
Castor Oil	1	1	1	1	1	Fatty Acids	1	0	0	1	1
Caustic Soda	1	3	2	1	1	Ferric Chloride	1	3	3	3	3
Cellosolve, Acetate	1	0	1	1	1	Ferric Nitrate	1	0	3	1	1
Cellosolve, Butyl	1	0	1	1	1	Ferric Sulfate	1	3	3	1	1
Cellulube	1	1	1	1	1	Ferrous Chloride	1	2	3	1	2
Cetyl Alcohol	0	0	0	0	0	Ferrous Nitrate	1	0	0	1	1
Chloroacetic Acid	1	2	3	3	3	Ferrous Sulfate	1	2	3	1	1
Chloral Hydrate	0	0	0	0	0	Fluorine	0	0	0	0	0
Chlorine, Gaseous, Dry	1	2	2	3	3	Fluoroboric Acid	1	0	0	1	1
Chlorine, Gaseous, Wet	1	3	3	3	3	Formaldehyde	1	1	0	1	1
Chlorine, Trifluoride	0	0	3	0	0	Formic Acid	1	2	3	2	1
Chloroacetic, Acid	1	2	3	3	3	Freon 12	2	0	3	1	1
Chlorobenzene	1	1	1	1	1	Freon 114	2	0	3	1	1
Chlorobenzene Chloride	0	0	0	0	0	Fuel Oil	1	1	2	2	2
Chlorobromomethane	1	1	1	1	1	Fumaric Acid	0	0	0	1	1
Chloroform	1	1	1	1	1	Furan Furfuran	1	1	1	1	1
O-Chloronaphthalene	1	1	1	1	1	Furfural	1	1	2	1	1
Chlorosulfonic Acid	1	0	3	0	1	Gallic Acid	1	0	3	1	1
Chlorotoluene	1	1	1	1	1	Gasoline	1	1	2	1	1
Chromium Trioxide	0	0	0	0	0	Glauber's Salt	0	0	1	1	1
Chromic Acid	1	3	3	3	2	Glucose	1	1	1	1	1
Citric Acid	1	3	3	3	1	Glue	1	3	2	1	1
Cod Liver Oil	1	1	1	1	1	Glycerin	1	1	2	1	1
Code Oven Gas	1	0	1	1	1	Glycerol	1	2	1	1	1
Copper Chloride	1	3	3	3	1	Glycols	1	1	1	1	1
Copper Cyanide	1	3	0	1	1	Green Sulphate Liquor	1	0	1	1	1
Copper Fluoride	0	0	0	0	0	Heptane	1	1	1	1	1
Copper Nitrate	0	0	0	0	0	n-Hexaldehyde	1	1	1	1	1
Copper Sulfate	1	3	3	1	1	Hexane	1	1	1	1	1
Corn Oil	1	1	1	1	1	Hexene	1	1	1	1	1
Corn Syrup	1	0	1	1	1	Hexyl Alcohol	1	2	1	1	1
Cottonseed Oil	1	1	1	1	1	Hydraulic Oil, Petroleum	1	1	1	1	1
Creosote	1	3	2	1	1	Hydrobromic Acid 10%	1	0	3	3	3
Cresol	1	0	2	1	1	Hydrobromic Acid 30%	1	0	3	3	3
Cresylic Acid	0	0	0	0	0	Hydrochloric Acid 10%	1	3	3	3	3
Crude Wax	1	1	1	1	1	Hydrochloric Acid 50%	1	3	3	3	3
Cutting Oil	1	1	1	1	1	Hydrochloric Acid Concentrate	1	3	3	3	3
Cyclohexane	1	1	1	1	1	Hydrocyanic Acid	1	0	3	0	1
Cyclohexanone	1	0	0	1	1	Hydrofluoric Acid					
Cymene	1	1	0	0	0	Concentrated	1	3	3	3	3
Decalin	1	1	0	0	0	Hydrofluoric Acid 40%	1	3	3	3	3
Denatured Alcohol	1	1	1	1	1	Hydrofluoric Acid 60%	1	3	3	3	3
Diacetone	1	1	1	1	1	Hydrofluosulfonic Acid	1	3	3	3	3
Diacetone Alcohol	1	1	1	1	1	Hydrogen Bromide	0	0	0	0	0
Dibenzyl Ether	1	1	1	1	1	Hydrogen Gaseous	1	1	1	1	1
Dibutyl Ether	1	1	1	1	1	Hydrogen Peroxide 70%	1	3	3	2	1
Dibutyl Phthalate	1	1	1	1	1	Hydrogen Sulfide Gaseous	1	3	3	2	1
Dibutyl Sebacate	1	1	0	0	0	Hydroquinone	0	0	0	1	1
Dichloroethylene	0	0	0	0	0	Hydroxylamine Sulfate	0	0	0	0	0
Dichlorobenzene	1	1	0	1	1	Iodine	0	0	0	0	0
Diesel Oil	1	1	1	1	1	Isobutyl Alcohol	1	2	1	1	1
Diethylamine	1	3	0	0	1	Iso Octane	1	1	1	1	1
Diethyl Ether	1	1	1	1	1	Isopropyl Acetate	1	1	1	1	1
Diethylene Glycol	1	1	1	1	1	Isopropyl Alcohol	1	1	1	1	1
Diethyl Phthalate	1	1	0	1	1	Isopropyl Ether	1	1	1	1	1
Diethyl Sebacate	1	1	0	1	1	Kerosene	1	1	1	1	1
Di-Isobutylene	0	1	0	1	1	Ketones	0	0	0	1	1
Di-Isopropyl Ketone	1	1	0	1	1	Lacquers	1	1	3	3	1
Dimethyl Aniline	1	1	0	0	0	Lacquers Solvents	1	1	3	2	1
Dimethyl Formamide	0	0	1	1	1	Lactic Acid	1	2	3	2	1
Dimethyl Phthalate	1	1	0	1	0	Lard	1	3	1	1	1
Dioctyl Phthalate	1	1	1	1	1	Lead Acetate	1	1	2	1	1
Dioxane	1	1	1	1	1	Lead Nitrate	1	1	2	1	1
Dipentene	1	1	1	1	1	Lyme Bleach	0	0	3	2	1
Ethanolamine	1	1	1	1	1	Linoleic Acid	1	0	0	0	0
Ethers	1	1	1	1	1	Linseed Oil	1	2	2	1	1
Ethyl Acetate	1	1	1	1	1	Lubricating Oils, Petroleum	1	1	1	1	1
Ethyl Acetoacetate	1	1	1	1	1	Magnesium Chloride	1	2	3	2	1
Ethyl Acrylate	0	0	1	1	1	Magnesium Hydroxide	1	0	1	1	1
Ethyl Alcohol	1	2	1	1	1	Magnesium Nitrate	0	0	0	0	0
Ethyl Benzene	1	1	1	1	1	Magnesium Sulfate	1	1	2	1	1
Ethyl Bromide	0	0	0	0	0	Malic Acid	1	0	2	2	1
Ethyl Cellulose	1	1	1	1	1	Mercuric Chloride	1	3	3	1	1
Ethyl Chloride	1	2	2	1	1	Mercury	1	3	1	1	1
Ethyl Ether	1	1	2	1	1	Mesityl Oxide	1	1	1	1	1
Ethyl Lactate	0	0	0	0	0	Methanol	1	1	0	1	1
Ethyl Mercaptan	1	0	2	0	0	Methyl Acetate	1	1	1	1	1
Ethyl Pentochlorobenzene	1	1	2	1	1	Methyl Acrylate	0	1	1	1	1
Ethyl Silicate	1	1	1	1	1	Methyl Alcohol	1	2	1	1	1
Ethylene Chloride	1	2	2	1	1						

CHEMICAL CHART

Chemical Resistance Chart

Media	End Fitting Material					Media	End Fitting Material				
	Teflon	Brass	CS	303/304 S.S.	316SS		Teflon	Brass	CS	303/304 S.S.	316SS
Methyl Bromide	1	1	1	1	1	Sodium Bicarbonate	1	2	2	1	1
Methyl Butyl Katone	0	1	1	1	1	Sodium Bisulfate	1	0	1	1	1
Methyl Chloride	1	1	1	1	1	Sodium Borate	1	0	1	1	1
Methylene Chloride	1	1	1	1	1	Sodium Chloride	1	3	2	2	1
Methylethyl Ketone (MEK)	1	1	1	1	1	Sodium Cyanide	1	3	2	1	1
Methyl Formate	1	1	1	1	1	Sodium Chlorate	0	0	0	0	0
Methyl Isobutyl Ketone	1	1	1	1	1	Sodium Hydroxide 30%	1	3	2	1	1
Methyl Methacrylate	1	0	1	1	1	Sodium Hydroxide 40%	1	3	2	1	1
Methyl Salicylate	1	1	1	1	1	Sodium Hydroxide 100%	1	3	2	2	1
Methyl Sulphate	0	0	0	0	0	Sodium Chlorite	0	0	0	0	0
Methyl Trichlorosilane	0	0	0	0	0	Sodium Metaphosphate	1	3	3	1	1
Milk	1	3	3	1	1	Sodium Nitrate	1	2	1	1	1
Mineral Oil	1	1	1	1	1	Sodium Perborate	1	3	3	1	1
Molasses	0	0	0	0	0	Sodium Peroxide	1	3	3	1	1
Monochlorobenzene	1	1	1	1	1	Sodium Phosphate	1	3	0	1	1
Monoethanolamine	0	1	1	1	1	Sodium Thiosulfate	1	3	3	1	1
Naptha	1	1	2	1	1	Soybean Oil	1	0	1	1	1
Napthalene	1	0	0	1	1	Stannic Chloride	1	3	3	0	0
Naphthenic Acid	1	0	0	2	1	Starch	0	0	0	0	0
Natural Gas	1	2	1	1	1	Steam	1	2	1	1	1
Nickel Acetate	1	1	1	1	1	Stearic Acid	1	3	3	2	1
Nickel Chloride	1	3	3	2	2	Stoddard Solvent	1	1	2	1	1
Nickel Nitrate	0	0	0	0	0	Styrene	1	2	2	0	2
Nickel Sulfate	1	3	0	2	1	Sucrose Solution	1	0	1	1	1
Niter Cake	0	0	3	2	1	Sulfur 200° F	1	3	2	2	1
Nitric Acid 5%	1	3	3	2	2	Sulfur Chloride	1	3	3	3	2
Nitric Acid 10%	1	3	3	2	2	Sulfur Dioxide	1	1	2	1	1
Nitric Acid 30%	1	3	3	2	2	Sulfur Dioxide Liquid	1	0	0	0	0
Nitric Acid above 30%	1	3	3	2	2	Sulfur Dioxide Wet Gas	1	0	0	0	0
Nitric Acid, Red Fuming	1	3	3	2	2	Sulfur Monochloride	0	0	0	0	0
Nitrobenzene	1	1	1	1	1	Sulfur Trioxide	1	0	2	2	2
Nitroethane	1	1	0	1	1	Sulfur Trioxide Liquid	0	0	0	0	0
Nitrogen, Gaseous	1	1	1	1	1	Sulfur Trioxide Wet Gas	0	0	0	0	0
Nitrogen Tetroxide	0	0	0	0	2	Sulfuric Acid 10%	1	3	3	3	2
Nitrous Acid	0	0	0	0	0	96%	1	3	3	3	2
Nitrous Oxide	0	0	0	0	0	98%	1	3	2	3	2
n-Octane	0	1	1	1	1	100%	1	0	0	0	0
Octyl Alcohol	1	2	1	1	1	Fuming	1	3	2	0	1
Oil, SAE	1	1	1	1	1	Sulfurous Acid 10%	1	3	3	2	1
Oleic Acid	1	2	2	2	1	Sulfurous Acid 75%	1	3	3	3	2
Olive Oil	1	2	2	2	1	Tallow	0	0	0	0	0
Oxalic Acid	1	3	3	2	1	Tannic Acid 10%	1	3	2	1	1
Oxygen Gaseous	1	1	1	1	1	Tar, Bituminous	1	2	1	1	1
Ozone	1	1	1	1	1	Tartaric Acid	1	0	0	2	2
Paint	1	1	0	1	1	Tetrachloroethylene	0	0	0	0	0
Palmitic Acid	1	3	1	2	1	Terpineol	1	0	0	0	0
Peanut Oil	1	1	1	1	1	Titanium Tetrachloride	0	3	1	2	2
Perchloric Acid	1	0	0	2	1	Toluene	1	1	1	1	1
Perchloroethylene	1	1	1	1	1	Toluene Disocyanate	0	0	0	0	0
Petroleum	1	1	1	1	1	Transformer Oil	1	1	1	1	1
Phenol	1	3	3	1	1	Transmission Fluid Type A	1	1	1	1	1
Phorone	1	1	1	1	1	Tributoxyethyl Phosphate	1	0	1	0	0
Phosgene	0	0	0	0	0	Tributyl Phosphate	1	0	1	0	0
Phosphoric Acid 20%	1	3	3	0	2	Trichloroacetic Acid 10%	0	0	0	0	0
Phosphoric Acid 100%	1	3	3	0	2	Trichloroacetic Acid 100%	0	0	0	0	0
Picric Acid	1	3	3	1	1	Trichlorethylene	1	1	3	0	1
Pinene	1	1	1	1	1	Trichloroethylene	1	0	3	0	1
Pine Oil	1	0	1	1	1	Trichlorophenol	0	0	0	0	0
Plating Solutions Brass	0	0	0	0	0	Tricresyl Phosphate	1	0	1	0	2
Cadmium	0	0	0	0	0	Tung Oil	1	1	1	1	1
Chrome	1	0	0	3	3	Turpentine	1	2	0	1	1
Potassium Acetate	1	0	0	1	1	Urea Solution 50%	1	0	1	1	1
Potassium Chloride	1	3	2	2	1	Urine	1	0	0	0	0
Potassium Cyanide	1	3	2	1	1	Varnish	0	2	2	1	1
Potassium Dichromate	1	0	0	1	1	Vegetable Oils	1	0	1	1	1
Potassium Hydroxide 30%	1	3	3	1	1	Versilube	1	1	1	1	1
Potassium Hydroxide 100%	1	2	3	1	1	Vinegar	1	3	3	2	1
Potassium Nitrate	1	2	3	1	1	Vinyl Acetate	0	0	0	0	0
Potassium Sulfate	1	2	2	1	1	Vinyl Chloride	1	3	2	1	1
Propane	1	1	1	1	1	Water	1	1	2	1	1
Propyl Acetate	0	1	1	1	1	Whiskey, Wines	1	3	3	2	1
Propyl Alcohol	1	2	1	1	1	Xylene	1	0	3	2	2
Pyridine 50%	1	1	0	1	1	Zinc Acetate	1	1	1	1	1
Red Oil	1	2	2	2	1	Zinc Chloride	1	3	3	2	1
Salicylic Acid	0	0	0	1	1	Zinc Sulfate	1	3	3	2	1
Salt Water	1	3	2	1	1						
Sewage	1	1	3	1	1						
Silicone Greases	0	1	1	1	1						
Silicone Oils	0	1	1	1	1						
Silver Cyanide	0	0	0	0	0						
Silver Nitrate	1	2	2	1	1						
Skydrol 500 & 7000	1	0	1	1	1						
Soap Solutions	1	1	1	1	1						
Soda Ash	0	2	1	1	1						
Sodium Acetate	1	1	1	1	1						
Sodium Benzoate	1	2	2	1	1						

Distributed by:

EVERFLEX[®]
ISO 9001 CERTIFIED

Eaton
14615 Lone Oak Road
Eden Prairie, MN 55344
USA
Tel: 952 937-9800
Fax: 952 974-7722
www.hydraulics.eaton.com